



ASSEMBLY GUIDE
with game instructions











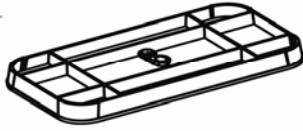

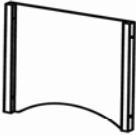





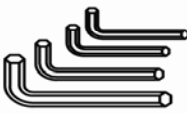

Carefully read this Manual before using
and keep it for further reference

Air Hockey **STRATOS**



Components

PARTS LIST

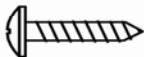
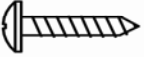
	<p>P1</p>  <p>Main frame 1 set</p>	<p>P2</p>  <p>Leg 4 pcs</p>
<p>P3</p>  <p>Panel 4pcs</p>	<p>P4</p>  <p>Leg leveler 4pcs</p>	<p>P5</p>  <p>Electronic scorer 1 set</p>
<p>P6(A)</p>  <p>Switch box(A) 1 pc</p>	<p>P6(B)</p>  <p>Pole base(B) 1 pc</p>	<p>P7(R)</p>  <p>Brace pole - right 2pcs</p>
<p>P7(L)</p>  <p>Brace pole - left 2pcs</p>	<p>P8</p>  <p>Storage bracket 2pcs</p>	<p>A1</p>  <p>Hockey striker 4 pcs</p>
<p>A2</p>  <p>Hockey puck 4pcs</p>	<p>A3</p>  <p>Tool 4pcs</p>	<p>A4</p>  <p>Adaptor 1pc</p>
<p>H1</p>  <p>1/4"x2" Bolt 16pcs</p>	<p>H2</p>  <p>1/4"Washer 16pcs</p>	<p>H3</p>  <p>3/8"x2" Bolt 12pcs</p>
<p>H4</p>  <p>3/8"Washer 12pcs</p>	<p>H5</p>  <p>Bolt / Lock Nut 2pcs</p>	<p>H6</p>  <p>3/16"x1-5/8" Bolt 4pcs</p>
<p>H7</p>  <p>3/16" Lock Nut 4pcs</p>	<p>H8</p>  <p>#7x1" Screw 4pcs</p>	<p>H9</p>  <p>#7x1/2" Screw 8pcs</p>

Garlando does not accept any responsibility for damages resulting from disregarding these instructions. Subject to colour changes and technical changes. Please keep this packaging for possible future correspondence.

Assembly, disassembling, part replacing

Place the air hockey table on even and stable surface. Always place a protective layer (cardboard or carpet) under the table legs to protect your floors.

Assembly (and, whenever necessary, disassembling and part replacing) should be carried out entirely by adults. Keep children away during all assembly steps to avoid that they may be fortuitously hit by the table components as well as preventing them from seizing parts that, if improperly used, could be very dangerous. The small parts (such as screws and bolts) not yet assembled may be swallowed or inhaled: keep them away from children.

Once assembled your air hockey table is quite wide and may not fit through your doors. For this reason you should assemble it in the room you intend it to be used. Should you wish to move your table to another room, it might be necessary to remove its legs.

CAUTION: To avoid any problems in the assembly or fastening of the table legs, first screw on all of the legs loosely at the same time and only tighten them later.

Step 1

Unpack all contents and out on the floor. Verify all parts listed on parts list are present.

Locate 2 legs **P2** and 2 leg panels **P3**. Attach the leg panels to the legs using bolts **H1** and washers **H2**.

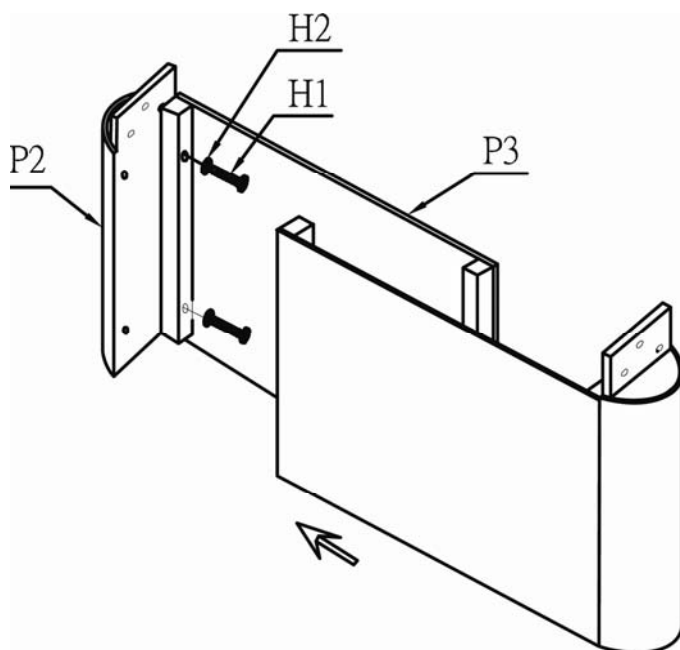
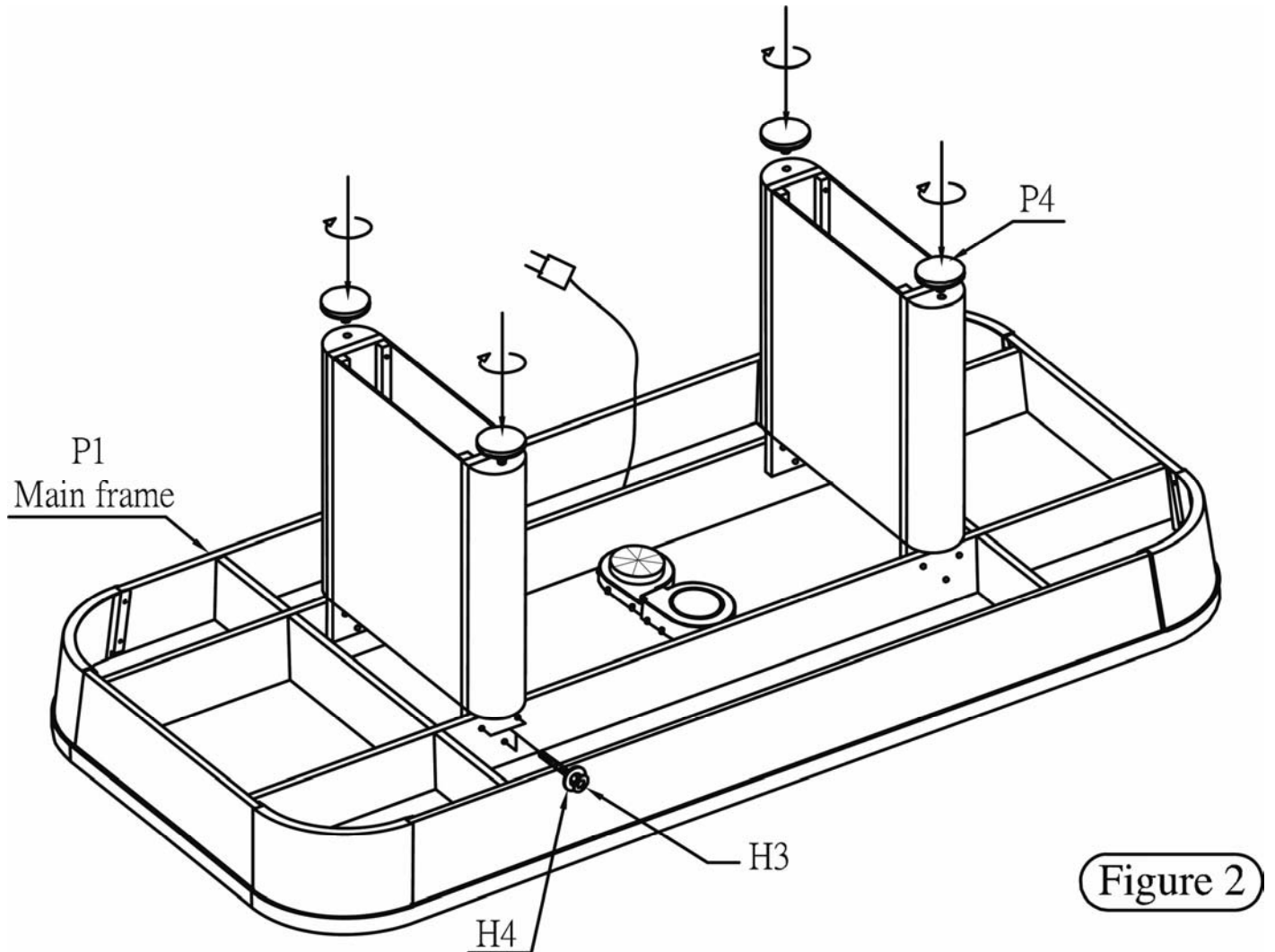

Figure 1

Step 2

Attach the two previously made leg assemblies to the bottom of the tables using bolts **H3**, washers **H4**.

Screw the leg levellers **P4** into the bottom of each leg.



Step 3

Feed the scoreboard wire down through the **P7L** pole. Secure the scoreboard to both brace poles using **H5** bolts/locknuts.

Now feed the scoreboard wire down through the **P6A** switchbox. Insert and secure the brace poles to the switchbox using **H6** bolts and **H7** locknuts.

Connect the 5-pin plug from the scoreboard wire to the 5-pin plug from the switchbox. This wire group will be placed inside the switchbox before you attach it to the top rail.

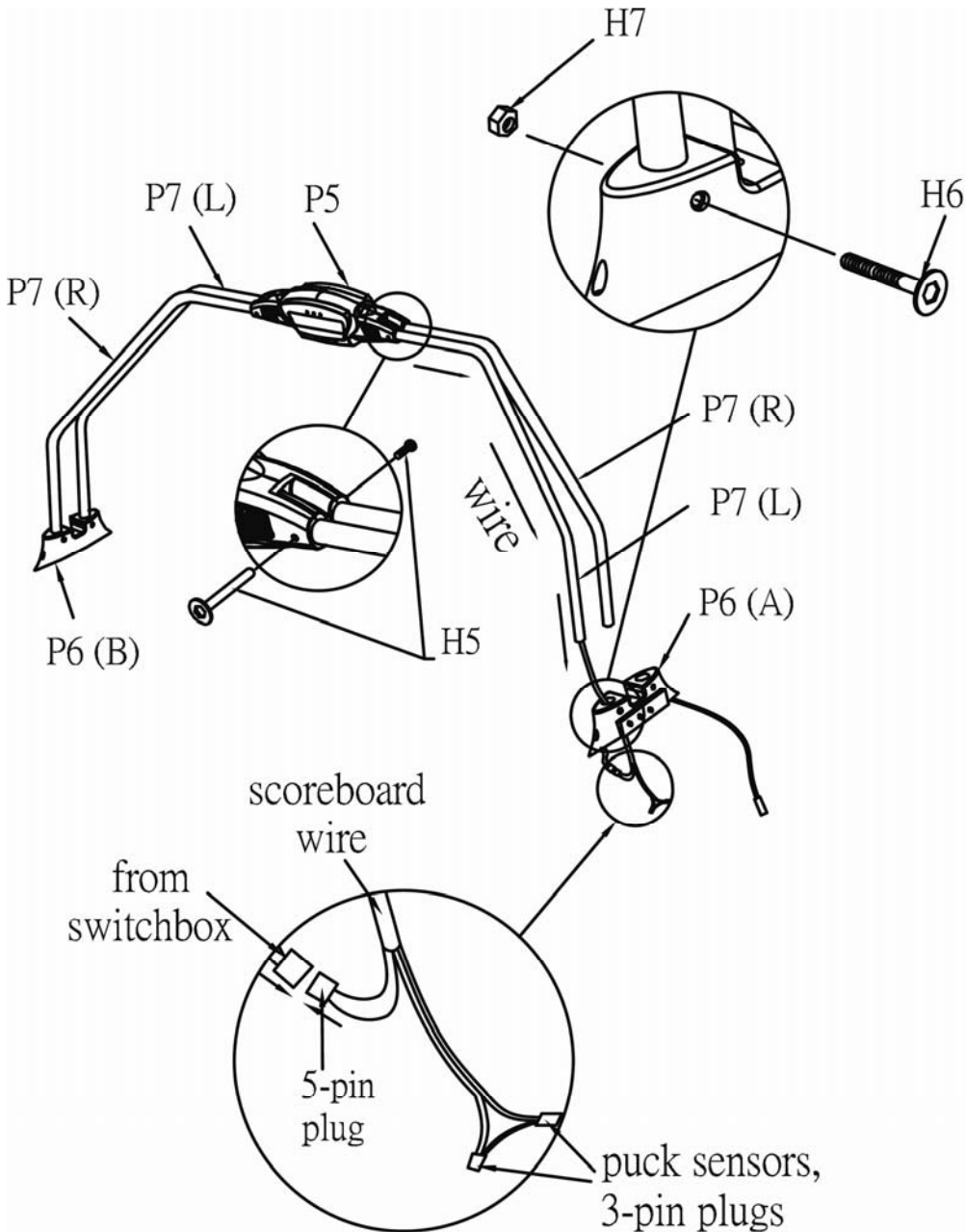

Figure 3

Step 4

First attach the base of scoreboard assembly **P6B** to the top rail using **H8** screws. Next feed the wiring from the **P6A** switchbox (3-pin plugs, power strip, female adaptor plug) down through the top rail and secure the base **P6A** on the top rail using **H8** screws.

Connect the 3-pin puck sensor plugs from the main circuit wire to the 3-pin sensor plugs from each goal.

Plug the adaptor into the white power strip from the switchbox and connect the other end to the adaptor to the female plug from the switchbox.

Insert the plug from the fan motors into one of the remaining outlets on the power strip. Now insert the 2-prong plug from the switchbox directly into the wall outlet. Now you will be able to fully operate all functions of the table using the green and red buttons on the switchbox.

Attached the storage brackets **P8** to the brace poles using screws **H9**.

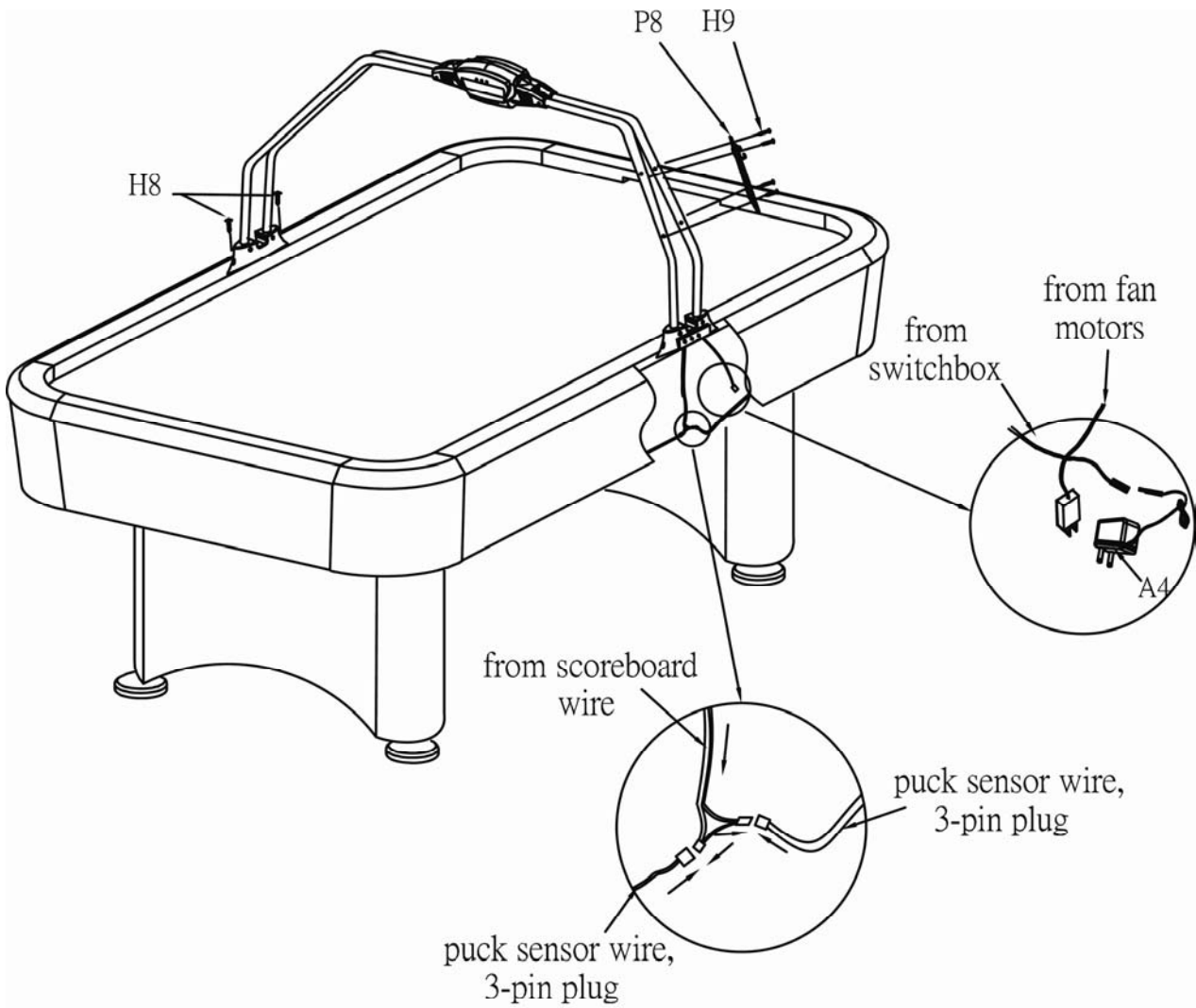
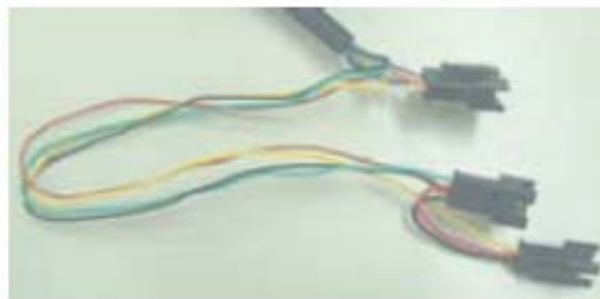

Figure 4

Deluxe Electronic Scorer – Assembly Instructions



- 1) Place main circuit line into fixing tube to switch box which includes one 5-pin connector and two 3-pin sensor connectors.



- 2) Connect 5-pin connector of main circuit line to 5-pin connector from switch box. This connection will be placed in switch box.

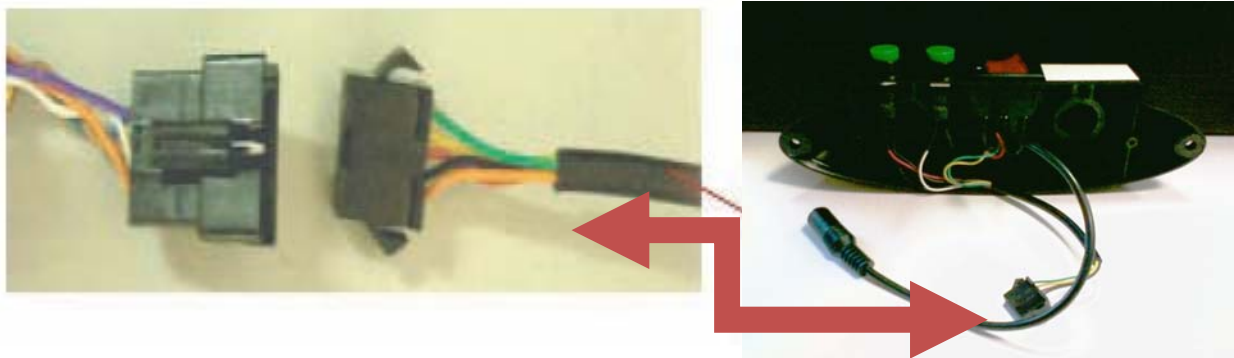

- 3) Connect two 3-pin sensor connectors from main circuit line to sensor connectors from puck collector. The connection position is under the hockey table.

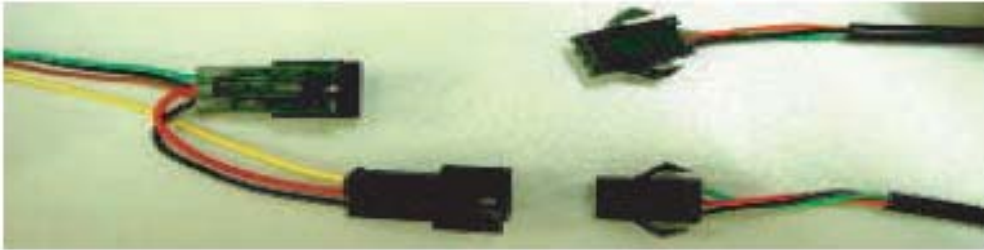

- 4) Plug 6V DC adaptor to AC plug (white) and connect the output plug from 6V DC adaptor to female plug from switch box.



Attention !

For a correct fixing of the adaptor please place the supplied velcro-band as shown in the beneath picture around the multiple-socket.



GAME INSTRUCTION

Before each use, check that all parts are functioning correctly and do not use the air hockey table if that is not the case.

- 1) Turn on the power and listen to the start up music. After the start up music the “thirty minutes” voice will be played and the 30 LED will be flashing. The scorer is now at stand-by mode. You can just now start a 30 minute game.
- 2) You can press “SELECT” key to select game modes: 30 minutes, 20 minutes, 10 minutes, points. The corresponding LED will be on and the game time will be shown on central display.
- 3) After the game mode has been selected you can press “RESET” key to start playing. At this time the corresponding LED will stop flashing and both side of home and visitor’s score will cleared to zero. The game will be started after the start music has been played and the game time will start to count down.
- 4) All display will be shutdown after 5 minutes of stand-by if no game has been started. You can wake up th scorer by pressing “RESET” key or “SELECT” key.

- 5) After the game has been started, if home or visitor has gained points, their score will be increment only by one, the cheering voice will be played. After the voice has been played, the next point can be counted.
- 6) There will be a “two minutes” warning when game time has only 2 minutes left.
- 7) After the game time is up, the scorer will play “home win” or “visitor win” depends on which time has more scores. After that the scorer will enter stand-by mode.
- 8) If both teams have the same score when the time is up, the game will be extended by 2 minutes.
- 9) If both teams still get the same score after 2 minutes extended period, it will be a “tie game” and the game is over.
- 10) You can press “RESET” key to abort the current game.

Warning

- 1) Should you pass on the air hockey table to another person, please make sure that this person is aware of the assembly and user instructions.
- 2) Please unplug power adaptor from outlet if you would not play it for a long time.
- 3) Please do not splash water or other fluid over hockey unit to prevent damages.
- 4) The sensor units must be plugged and aim at each other before the scorer power is turned on.
- 5) To reset the score counter you can simply turn off the power then turn on again. The normal function of the product may be disturbed by strong electro magnetic interference. If so, simply reset the product to resume normal operation by following the instruction manual. In case the function could not resume, please use the product in other location.

Care & Maintenance

In order to ensure its long life and continued playing appeal, we recommend that you follow the simple instructions below:

Your air hockey table has been manufactured for indoor playing: do not leave it outdoors. Rain, snow and high humidity may damage its materials. Prolonged exposure to the sun is to be avoided too, due to its ultraviolet effects which will ruin the colours.

Clean your air hockey table periodically. It is sufficient to wipe its surfaces using a damp cloth. For a deeper cleaning you can use an air compressed bomb to clear away the dust that could block the playing surfaces holes.

Guarantee conditions

If any faults occur, please contact the dealer from whom you purchased the article and then return it to him. Please make sure that it is properly packed (original packing) and enclose your receipt and a detailed description of the fault.

This air hockey table is only designed for private use. For commercial use, the warranty loses its validity. Please use this game exclusively for its intended purpose.

The guarantee period begins with the date of the invoice or delivery.

Repairs or any returns are ONLY possible in the original packing with proof of purchase and assembly. Otherwise fess will be charged !

The guarantee covers faults in manufacturing and materials. It does not cover damage caused by incorrect use or *force majeure* or natural wear and tear.

During the period covered by the guarantee, you are entitled to have repairs carried out. This means that we will remedy any faults free of charge up to the expiry of the guarantee period valid at the time of purchase. After the expiry of the guarantee period, a charge will be made for carriage and packing costs. If necessary, we will replace the article as a whole or parts thereof. If our efforts during the period of the guarantee valid at the time of purchase are not successful or if repair is not worthwhile, you also have the right at your choice to cancel the contract (conversion) or to receive a reduction in the purchase price (redhibition).

Please notify us immediately of any fault. Obvious faults, including transport damage, will only be recognized by us when reported to us within one week of delivery at the latest.

Please note!

Complaints can ONLY be processed when this product is returned in the original packing – no exceptions. Please enclose the assembly guide/instructions for use, a detailed description of the fault and receipt. Only the original packing guarantees adequate transport protection of the goods and should therefore be stored during the guarantee period.



Product correct disposal

in compliance with RAEE (Waste from Electrical and Electronic Appliances) D.Lgs. 151/2005

When the barred waste box symbol is found on a product, on its packing or its instructions, it means that at the end of its life cycle the product cannot be disposed of together with the standard domestic waste. To prevent damages to the environment or health caused by an incorrect waste disposal, the product must be disposed of separately and recycled in a responsible way to enable a sustainable re-use of material resources. Users are invited to contact their local organisations to obtain the necessary information for the disposal of the waste from the electrical and electronic appliances. In the event a new product belonging to the same category is purchased, it is possible to return the old one to the manufacturer. An incorrect disposal of the product is liable to punishment in accordance with the current applicable law.

Importer:

GARLANDO S.p.A.
Via Regione Piemonte 32, Zona Ind. D1
15068 - Pozzolo Formigaro (AL) Italy
Tel. +39.0143.318500
Fax +39.0143.318557
info@garlando.it
www.garlando.it

Distribution:

Garlando GmbH
Obere Kaiserswerther Strasse 36
47249 Duisburg (Germany)
Tel. +0049.0203.348338-10
Fax +0049.0203.348338-10
garlando@garlando.com
www.garlando.com