

Assembly & Exercise Guide

Carefully reading and keeping the operating
Instructions before use.

GHIBLI ***Mini - Air Hockey***



**CAUTION! CAREFULLY READING AND KEEPING THE OPERATING INSTRUCTIONS BEFORE USE.
NOT SUITABLE FOR CHILDREN BELOW THE AGE OF 3, AS THERE IS A CHOKING HAZARD FROM SWALLOW ABLE
SMALL PARTS.**



Congratulations! You have bought a first quality AIR HOCKEY table. It is an indoor AIR HOCKEY table: please assemble it and use it indoors only.

ASSEMBLY AND DISMANTLING MUST ONLY BE CARRIED OUT BY ADULTS.

IMPORTANT:

This AIR HOCKEY table is only designed for private use. For commercial use, the warranty loses its validity. Please use this game exclusively for its intended purpose.

In order to ensure its long life and continued playing appeal, we recommend that you follow the simple instructions below:

- (1) Your AIR HOCKEY table has been manufactured for indoor playing: do not leave it outdoors. Rain, snow and high humidity may damage its materials. Prolonged exposure to the sun is to be avoided too, due to its ultraviolet effects which will ruin the colours.
- (2) Clean your AIR HOCKEY table periodically. It is sufficient to wipe its surfaces using a damp cloth. For a deeper cleaning you can use any household detergent which does not contain wax or abrasives.
- (3) Should you pass on the AIR HOCKEY table to another person, please make sure that this person is aware of the assembly and user instructions.
- (4) Always place the AIR HOCKEY table on even and stable surfaces.
- (5) Before each use, check that all parts are functioning correctly and do not use the AIR HOCKEY table if that is not the case.
- (6) Always place a protective layer (cardboard or carpet) under the table legs to protect your floors.
- (7) CAUTION: To avoid any problems in the assembly or fastening of the table legs, first screw on all of the legs loosely at the same time and only tighten them later.

**WINSPORT DOES NOT ACCEPT ANY RESPONSIBILITY FOR DAMAGES RESULTING FROM DISREGARDING THESE INSTRUCTIONS.
SUBJECT TO COLOUR CHANGES AND TECHNICAL CHANGES. PLEASE KEEP THIS PACKAGING FOR POSSIBLE FUTURE
CORRESPONDENCE.**

ATTENTION

Don't put your fingers into any wall sockets!!!

ACHTUNG

Die Finger NICHT in die Steckdose stecken!!!

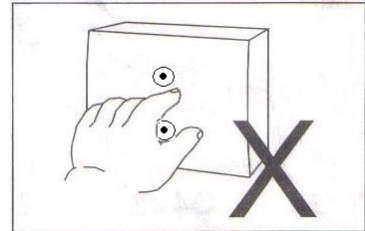
**ATTENTION**

Make sure that the transformer sockets is not close to any wet areas.

ACHTUNG

Den Transformator NICHT in feuchten Räumen oder Wasser benutzen!!!

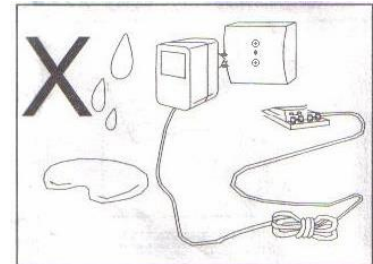
**ATTENTION**

Make sure that the transformer sockets is not close to open fire.

ACHTUNG



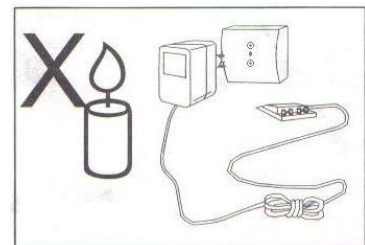



Den Transformator NICHT in der Nähe von Heizkörpern und offenem Feuer benutzen!!!

**ATTENTION** NOTE FOR TRANSFORMER:

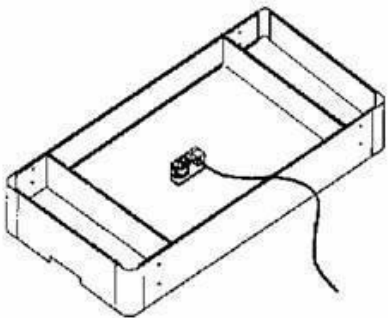
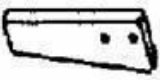
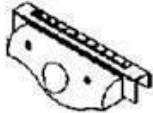
Transformer used with the toy are to be regularly examined for damage to the cord, plug, enclosure and other parts, and that, in the event of such damage, the toys must not be used with this transformer until the damage has been repaired. The toy must only be used with the recommended transformer. The transformer is not a toy.

ACHTUNG WARNUNG ZU DEM TRANSFORMATOR

Der Transformator ist kein Spielzeug und ausschließlich für das originale Spiel in dieser Verpackung gedacht. Von Zeit zu Zeit das Kabel, den Stecker und den Transformator kontrollieren. Nicht im Freien benutzen. Das Einfügen des Streckers in die Steckdose sorgfältig durchführen.

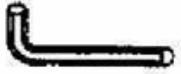
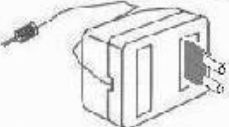
Componenti / Components / Bestandteile		
<p>P1 1 Pz. / Pcs. / St.</p>  <p>Telaio Frame Hauptbauteil</p>	<p>P2 4 Pz. / Pcs. / St.</p>  <p>Gamba Leg Bein Platte</p>	<p>P3 2 Pz. / Pcs. / St.</p>  <p>Raccogli disco Disk basket Tor</p>
	<p>H1 8 Pz. / Pcs. / St.</p>  <p>Vite Screw Innensechskantschraube</p>	<p>H2 8 Pz. / Pcs. / St.</p>  <p>Rondella Washer Schwarze unterlegscheibe</p>
<p>H3 2 Pz. / Pcs. / St.</p>  <p>Vite Screw Kreuzschlitzschraube</p>	<p>A1 4 Pz. / Pcs. / St.</p>  <p>Manopola Hockey Handle Hockey spieler</p>	<p>A2 4 Pz. / Pcs. / St.</p>  <p>Disco Hockey disk Hockey puck</p>
<p>A3 1 Pz. / Pcs. / St.</p>  <p>Chiave esagonale Hexagonal key Inbusschlüssel</p>	<p>A4 1 Pz. / Pcs. / St.</p>  <p>Trasformatore Transformer Transformator</p>	

Step 1

Please notice the following steps in detail:

You put the already preassembled Air hockey corpus on the head and use a softer underground to avoid around scratching traces. Fasten the foot part (# P2) respectively to the insides of the corpus already preassembled which are right and provided for it. You use the screws (# H1) and the washers (# H2) for it.

Make sure that all screws were screwed in duly.

The Air hockey can get unstable and lead use to injuries at improper by not firmly dressed screws.

If you have made sure about the proper condition of the assembly now, you can do turn over and put on the foot parts Air Hockey now.

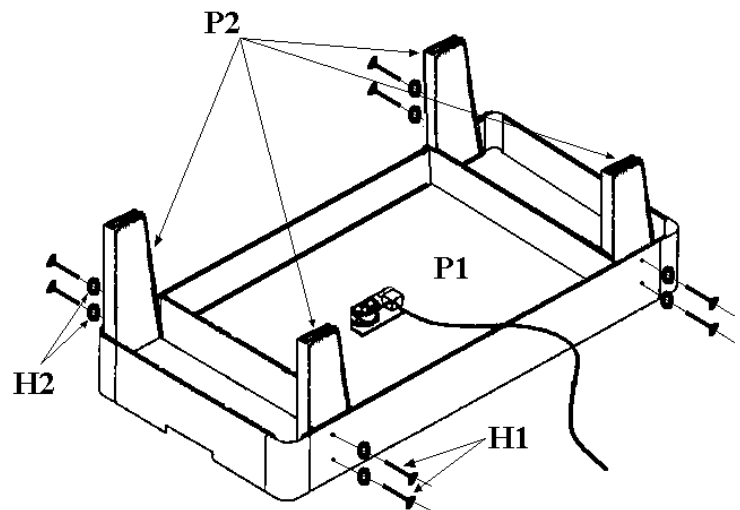

Step 2

Please notice the following steps in detail:

Finally put both gates (# P3) together with the wood screws (# H3) on the both short sides of the Air Hockey table now.

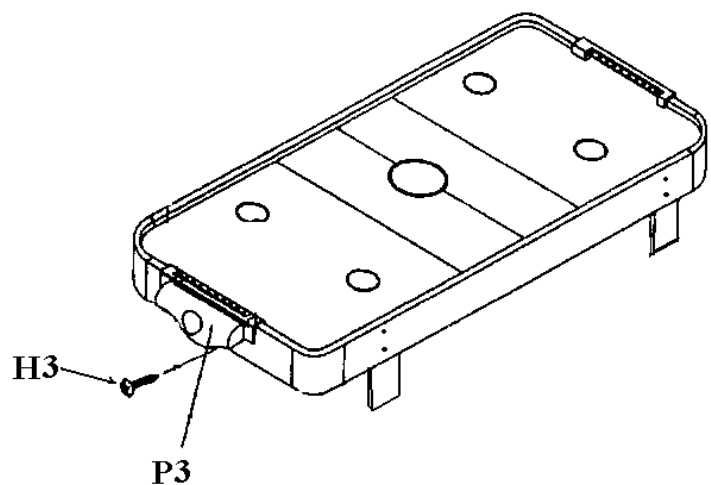

AIR HOCKEY TABLE DEMOLITION AND HARMFUL MATERIAL REMOVAL

Demolition

The AIR HOCKEY table doesn't require any particular care for the demolition since it doesn't have any parts produced with dangerous materials. The materials are:

The materials are: **Wood, MDF, Steel, Aluminium, ABS, PP, PE, PVC.**

These materials are present in the following parts:

Frame: Wood, MDF, Steel.

Legs: Wood, Steel

Playfield: Wood

Rods: Steel, PP.

Accessories: ABS, PE, PVC.

Finishing: Aluminium, ABS.

During AIR HOCKEY Table demolition we suggest the sharing of the different materials and their removal in authorized collection centre for their recycling.

Removal of harmful materials

The AIR HOCKEY Table doesn't produce any harmful substances.

Guarantee conditions

The guarantee period begins with the date of the invoice or delivery.

Repairs or any returns are **ONLY** possible in the original packing with proof of purchase and assembly and exercise guide.

Otherwise a charge will be made!

The guarantee covers faults in manufacturing and materials. It does not cover damage caused by incorrect use or *force major* or natural wear and tear.

During the period covered by the guarantee, you are entitled to have repairs carried out. This means that we will remedy any faults free of charge up to the expiry of the guarantee period valid at the time of purchase. After the expiry of the guarantee period, a charge will be made for carriage and packing costs. If necessary, we will replace the article as a whole or parts thereof. If our efforts during the period of the guarantee valid at the time of purchase are not successful or if repair is not worthwhile, you also have the right at your choice to cancel the contract (conversion) or to receive a reduction in the purchase price (retribution).

Please notify us immediately of any fault. Obvious faults, including transport damage, will only be recognized by us when reported to us within one week of delivery at the latest

Description of fault on return of goods

If any faults occur, please contact the dealer from whom you purchased the article and then return it to him. Please make sure that it is properly packed (original packing) and enclose your receipt and a detailed description of the fault.

Please note!

Complaints can **ONLY** be processed when this product is returned in the original packing – no exceptions (please enclose the assembly guide/instructions for use, a detailed description of the fault and receipt. Only the original packing guarantees adequate transport protection of the goods and should therefore be stored during the guarantee period.

Importeur:

Support info@winsport.de
Telefon 0049-(0)8234-904930
www.winsport.de

Winsport e.K.
Waldstrasse 21
86517 Wehringen
Germany

