

# 5107N

**Sport-Thieme**  
**Art.Nr.: 3042902**

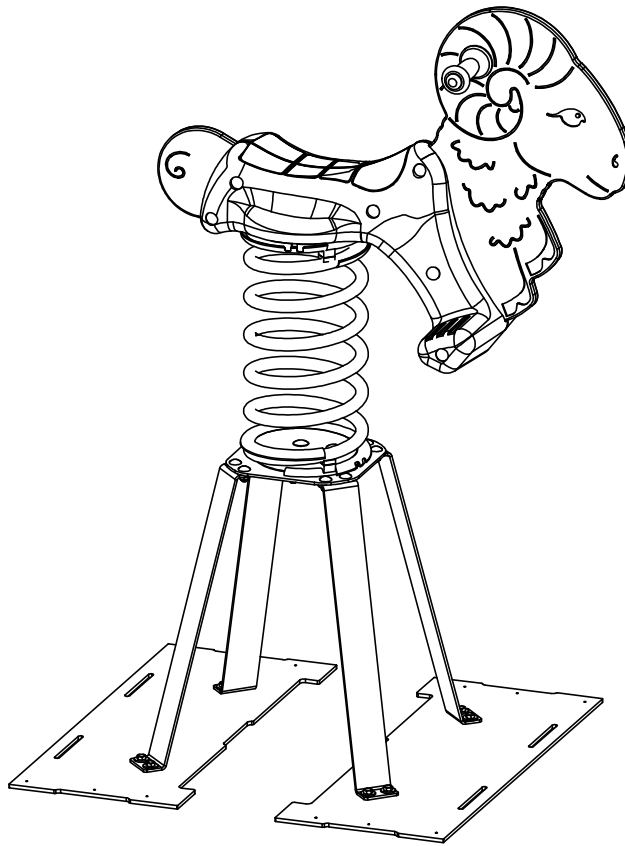

# 5107F

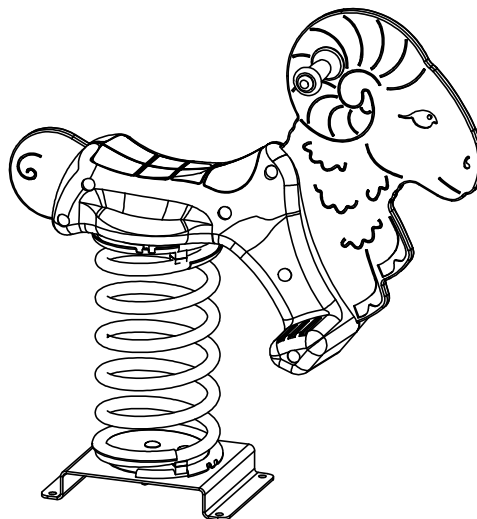

5107N  
5107F

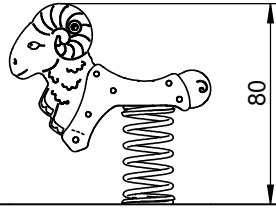

"0"

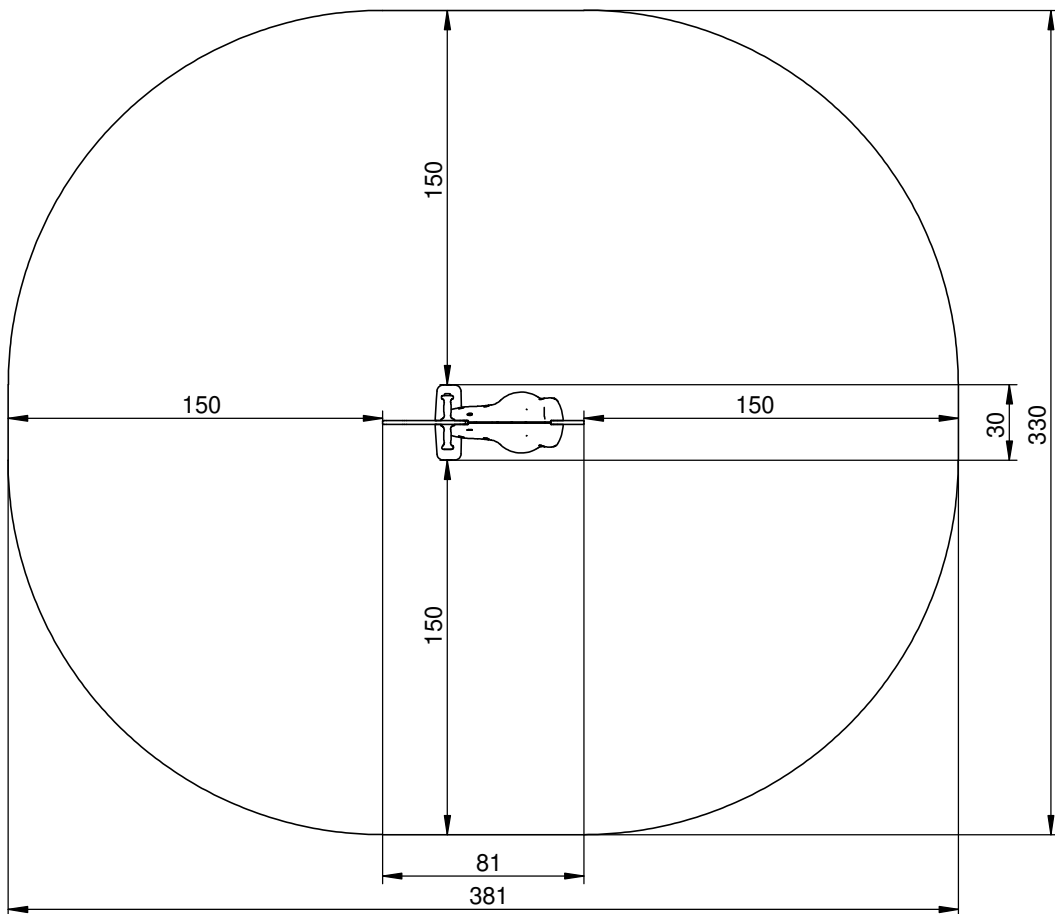

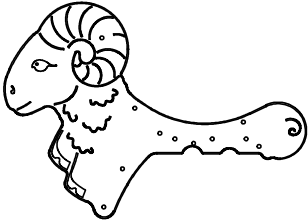
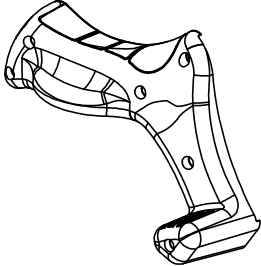
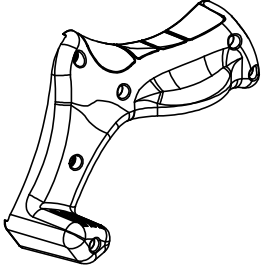
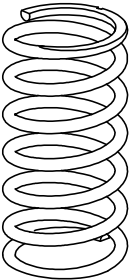
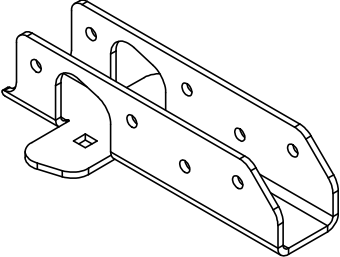
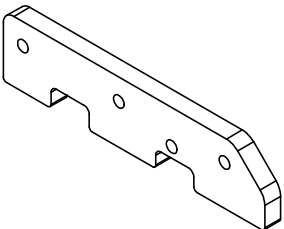
NR	ELEMENT	5107N
E1		1
E2		1
E3		1
E4		1
E5		1
E6		2

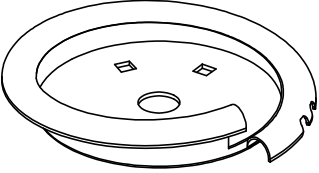
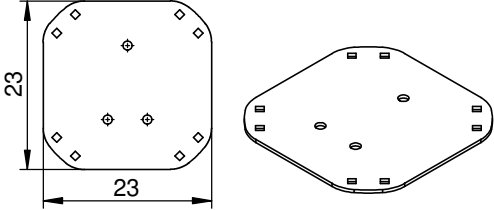
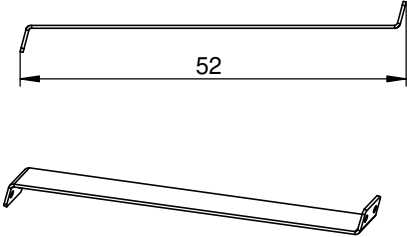
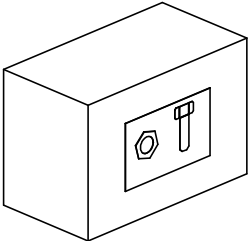
NR	ELEMENT	5107N
E7		2
E8		1
E9		4
E10		1

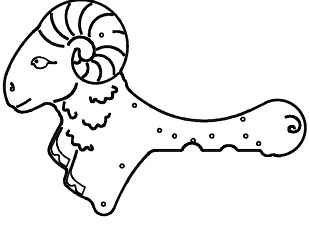
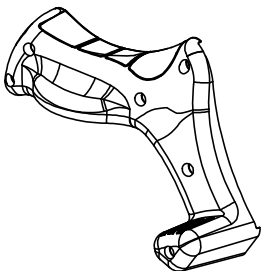
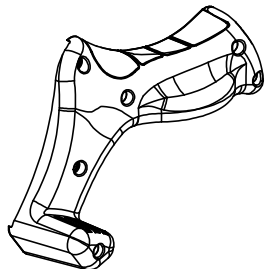
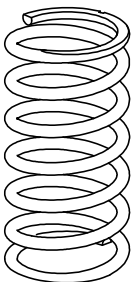
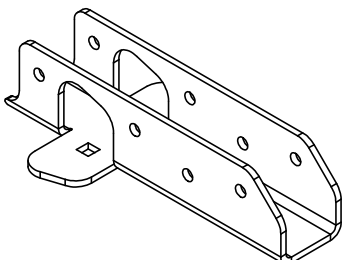
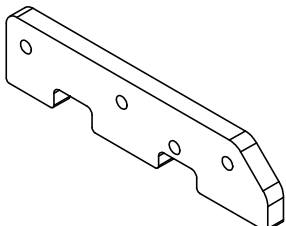
NR	ELEMENT	5107F
E1		1
E2		1
E3		1
E4		1
E5		1
E6		2

NR	ELEMENT	
E7		2
E8		1
E9		1

E7

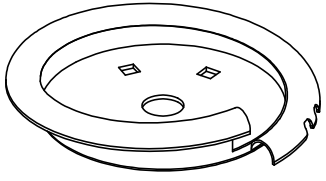

2

E8

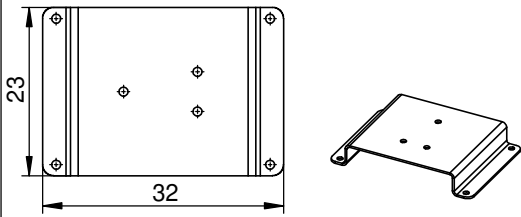

1

E9

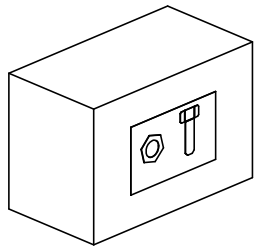













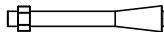





1



5107N

5107F

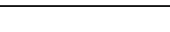
Nr	Element			$\Sigma$	$\Sigma$
4		DIN 125	10x20	2	2
5		DIN 985	M10	7	7
21		DIN 125	8x16	14	14
30		DIN 9021	8x24	24	
31		DIN 985	M8	26	10
61		-	KL105		4
103		DIN 9021	10x30	6	6
110		DIN 931	M8x35	8	
145		DIN 603	M10x30	6	6
152		DIN 931	M8x70	4	4
189		DIN 912	M8x200	1	1
190		-	K_B_1	2	2
191		-	R_B_1	2	2
192		-	R_B_Z_1	1	1
193		DIN 603	M8x20	8	
204		DIN 931	M10x200	1	1
203		-	Z_B_1_BR	12	12
214		-	Z_NA_2	1	1
216		DIN 912	M8x40	1	1
217		DIN 912	M8x80	4	4



**1** N, F

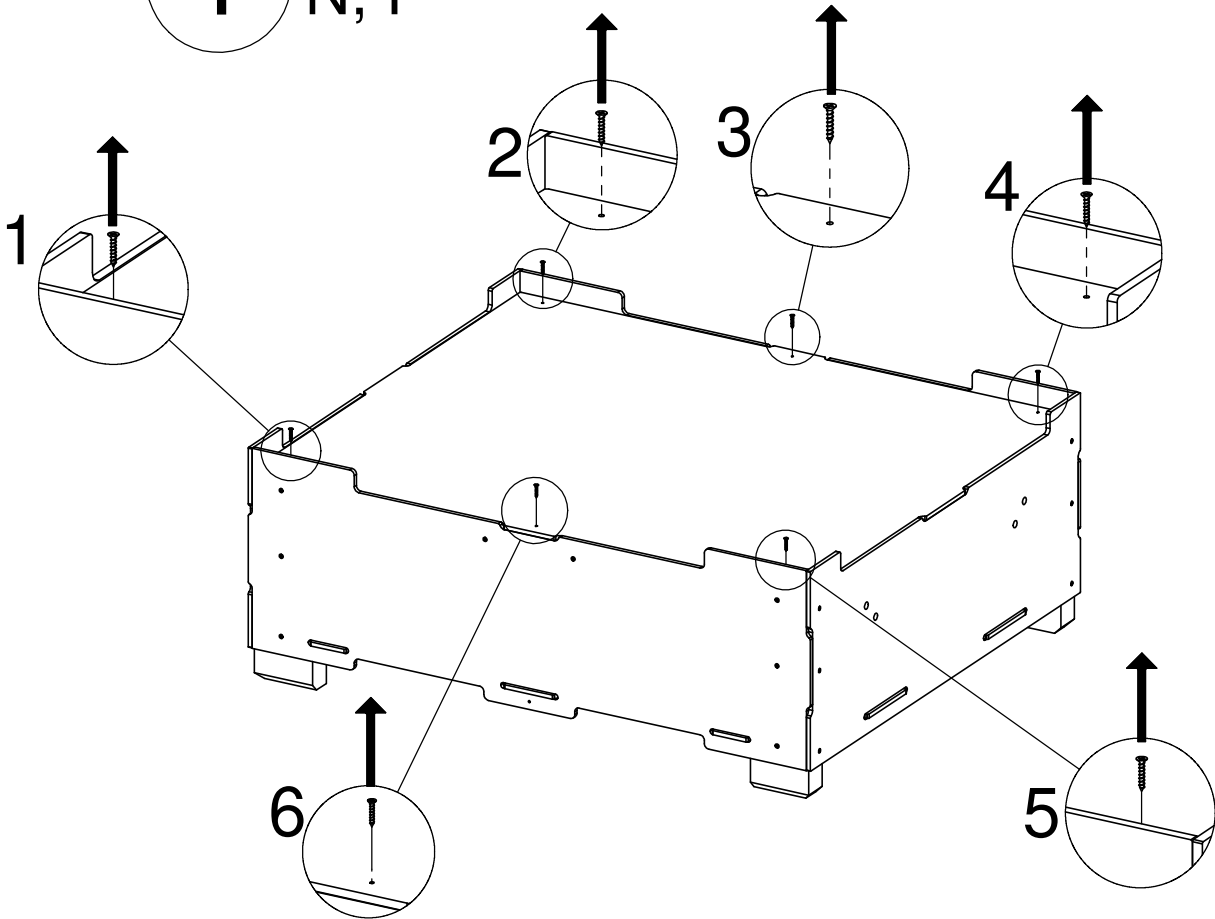

**2** N, F

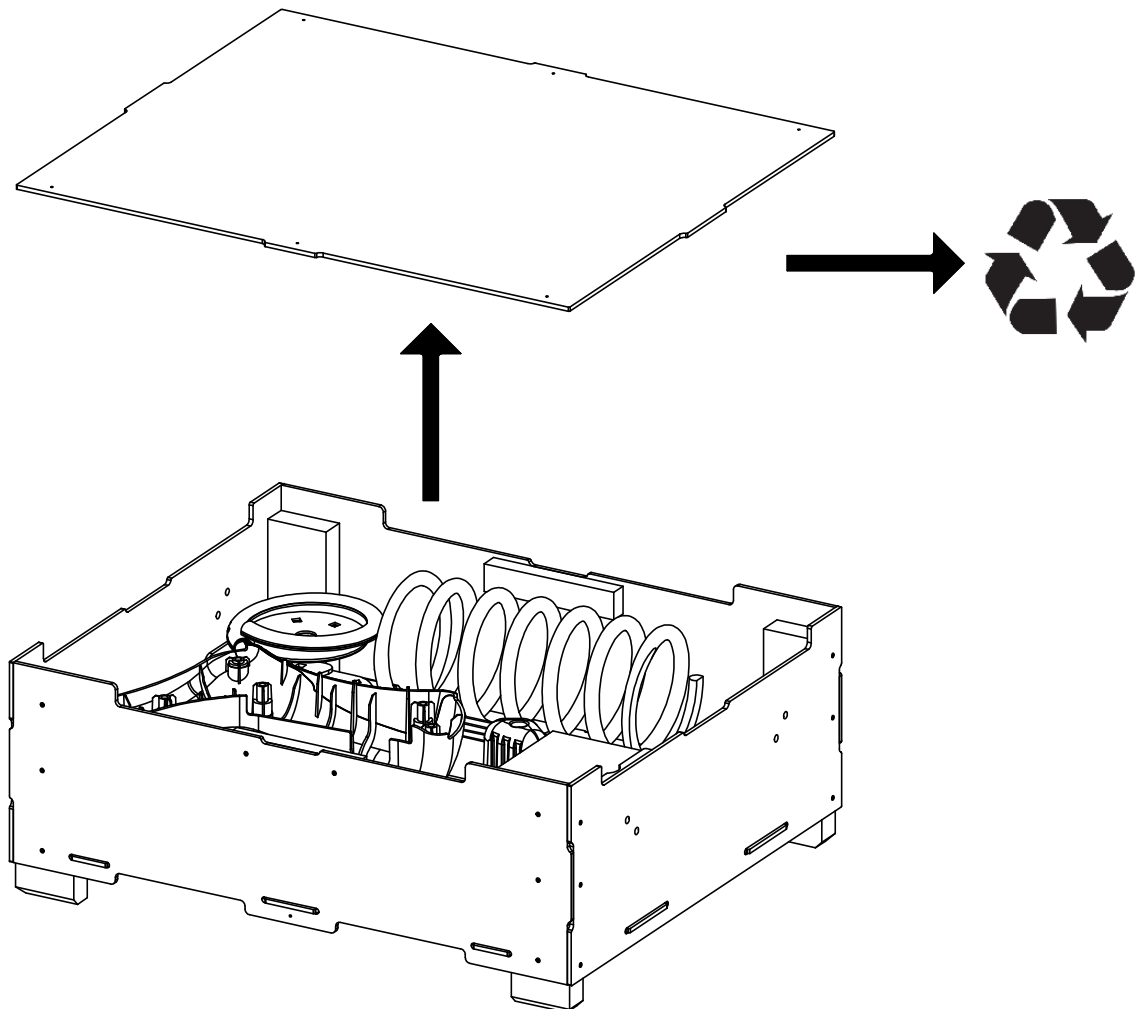

3 N, F

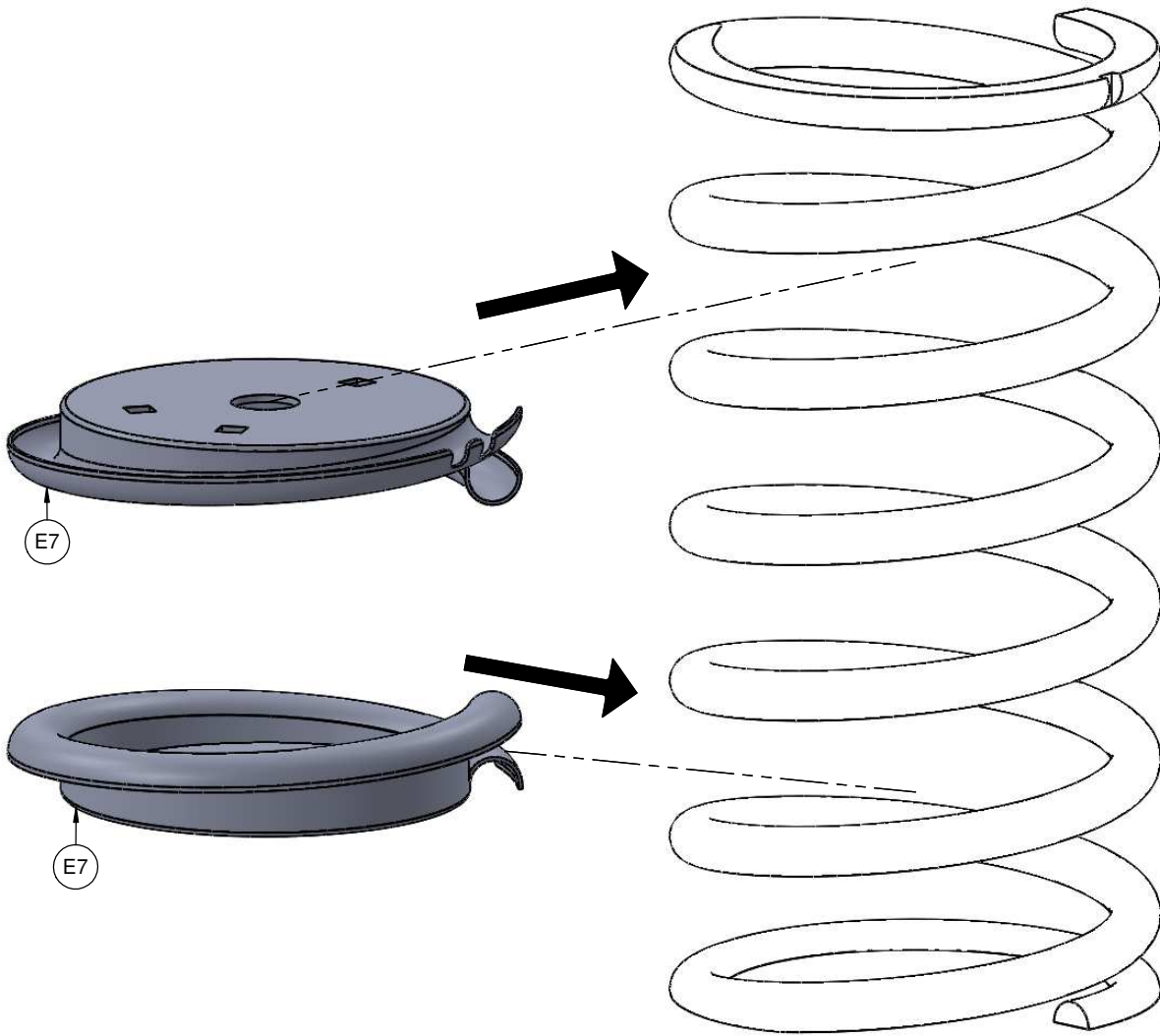

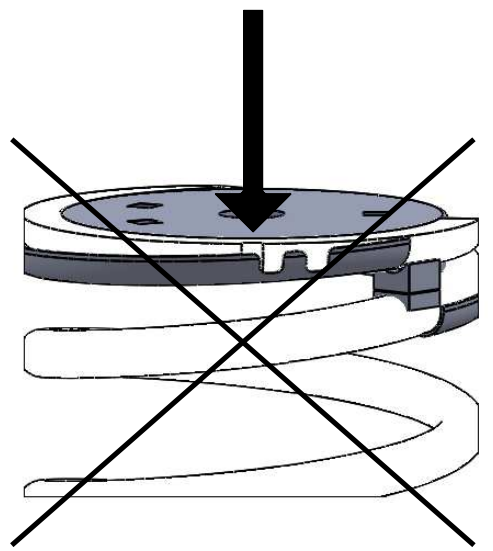
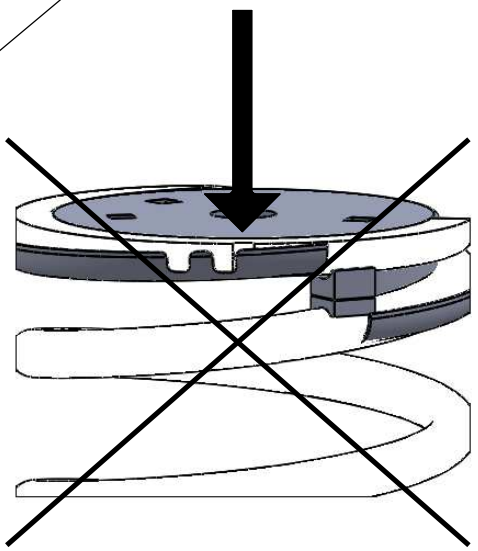
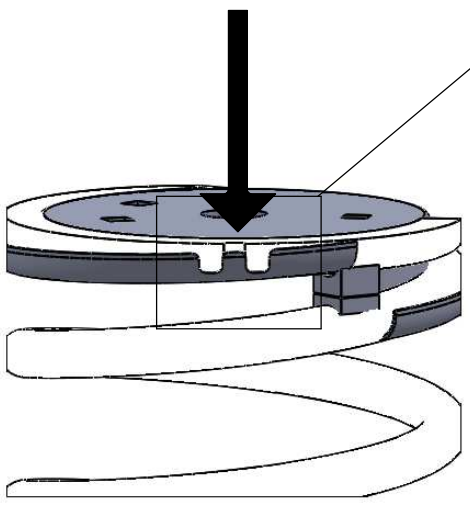
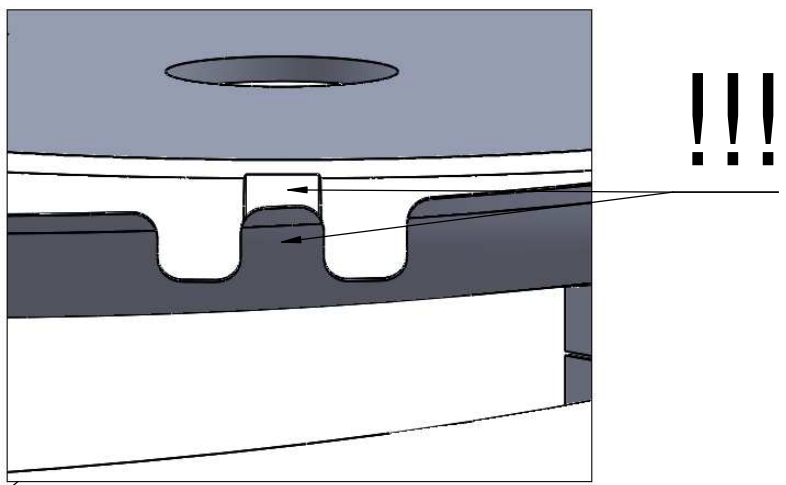
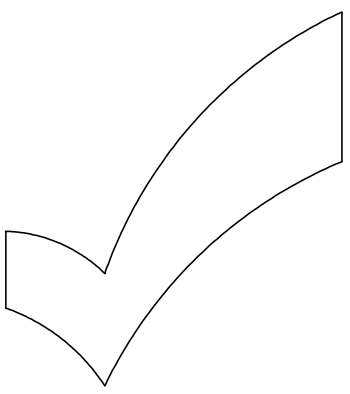
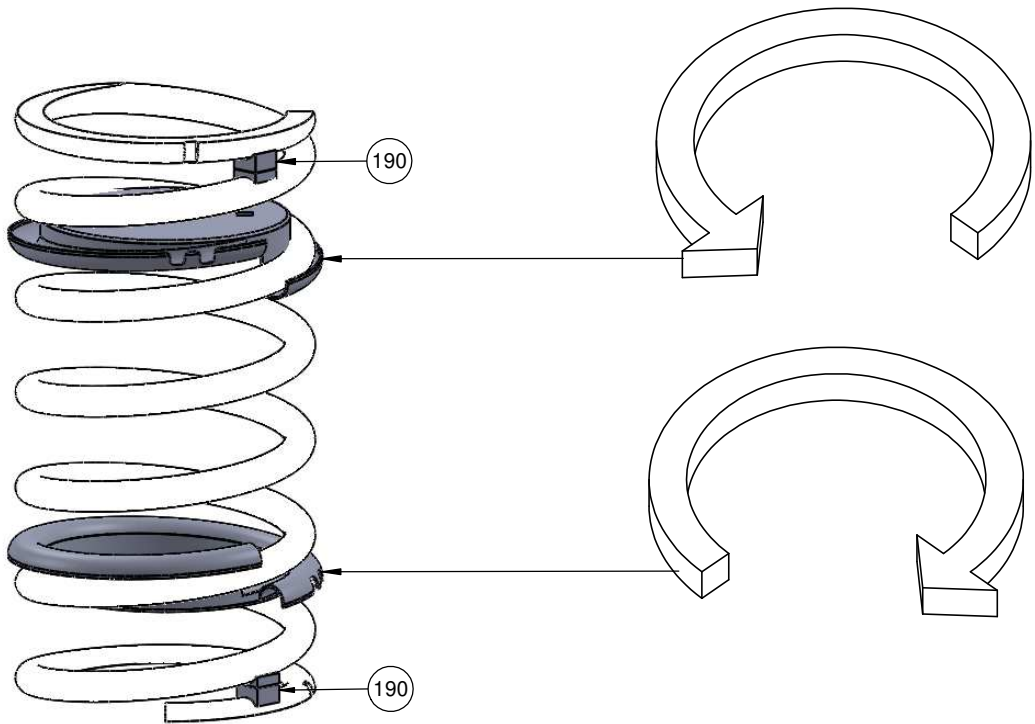

4 N, F

Nr	Element		Σ
190		-	K_B_1
			2



# 5 N, F

Nr	Element			Σ
5		DIN 985	M10	3
103		DIN 9021	10x30	3
145		DIN 603	M10x30	3

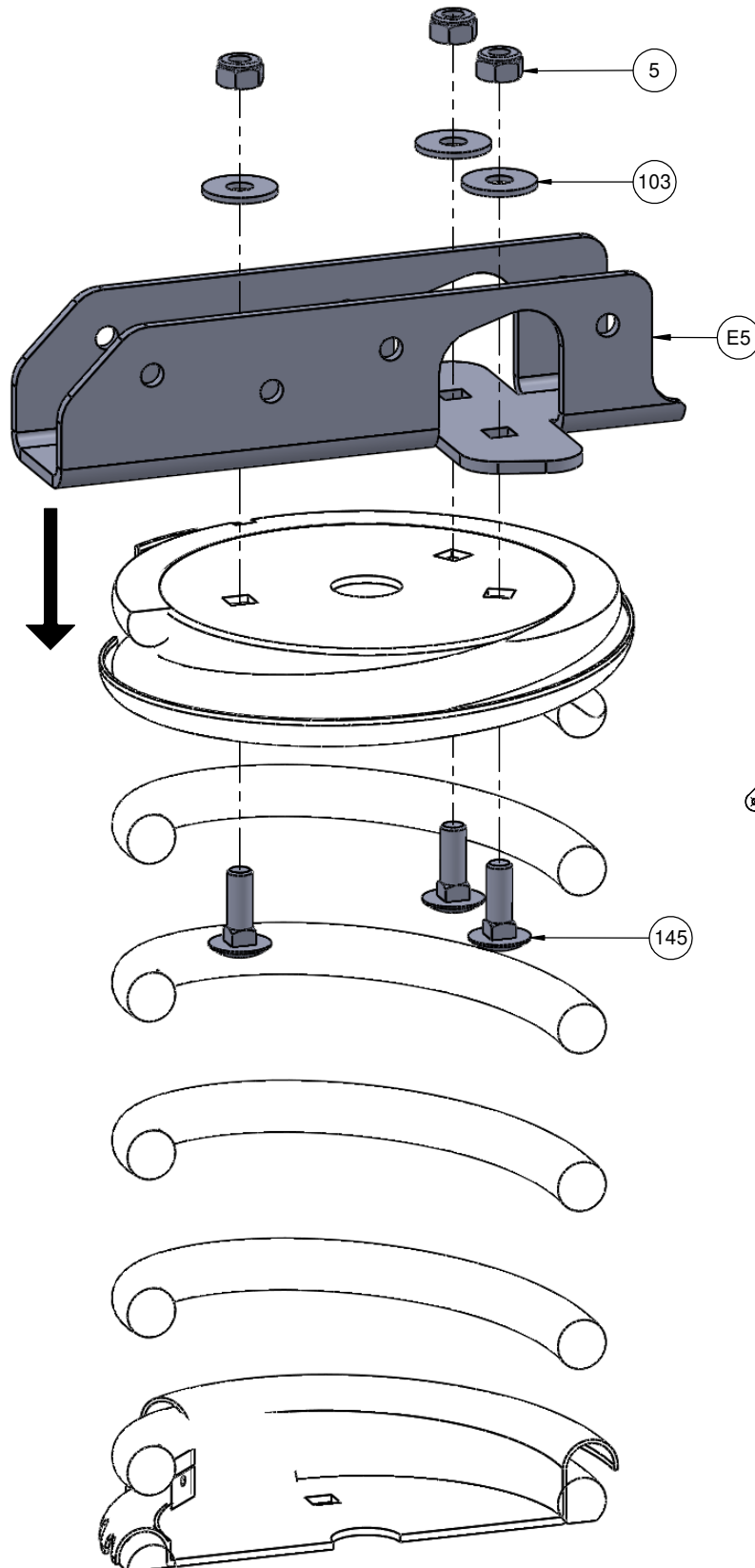

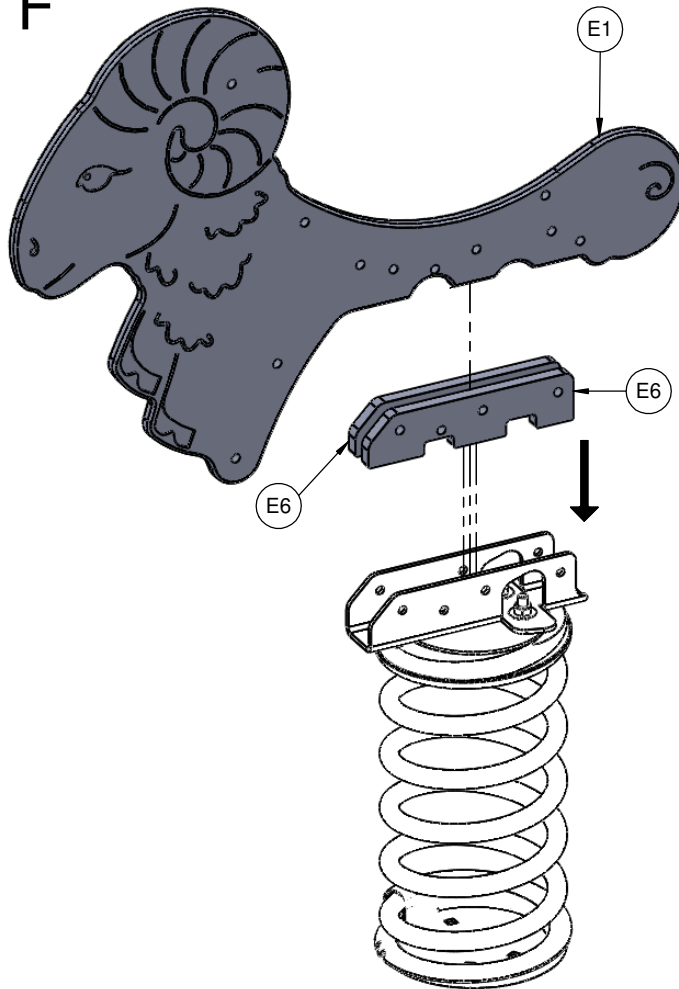

# 6 N, F

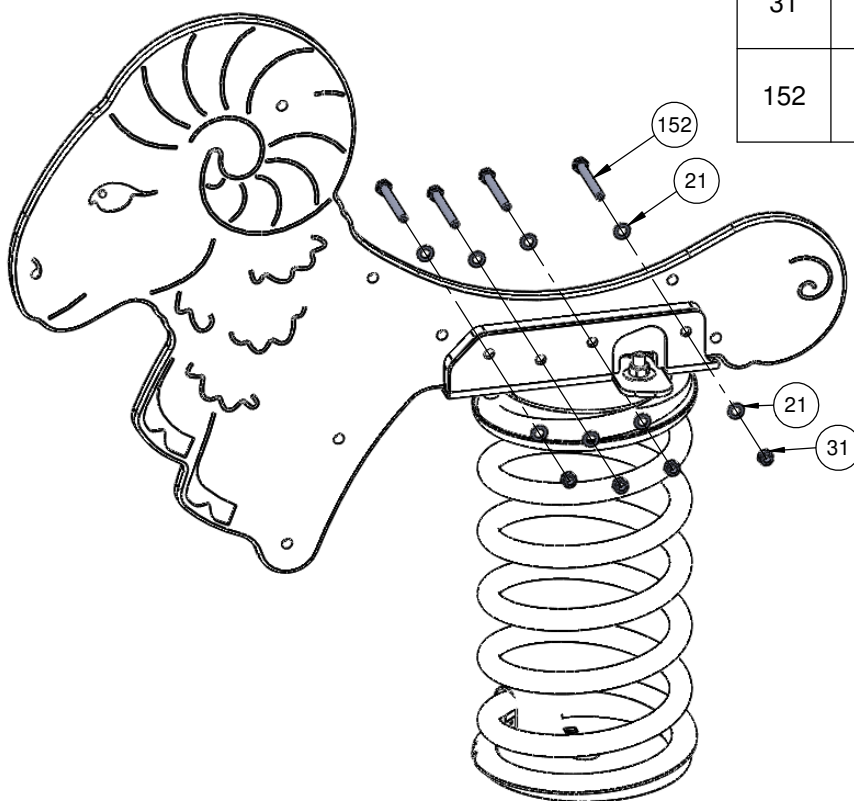

# 7 N, F

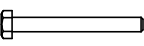

Nr	Element			Σ
21		DIN 125	8x16	8
31		DIN 985	M8	4
152		DIN 931	M8x70	4

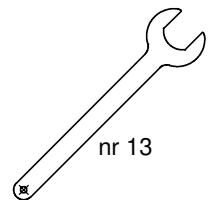

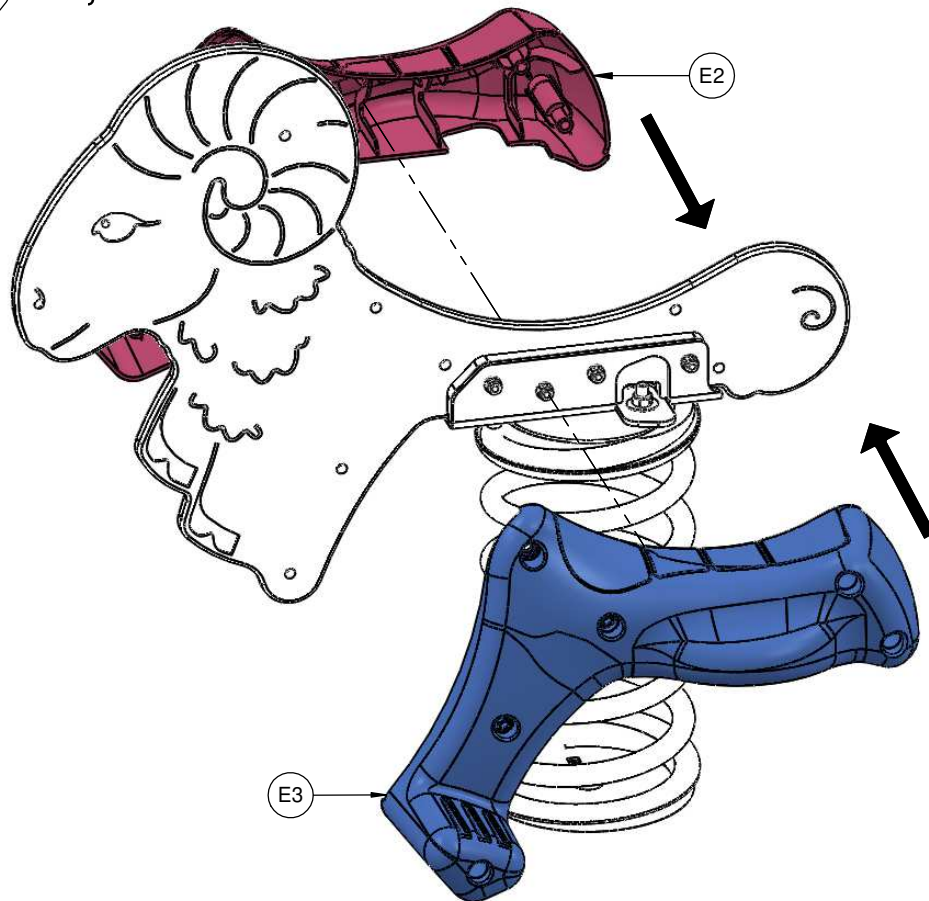

# 8 N, F



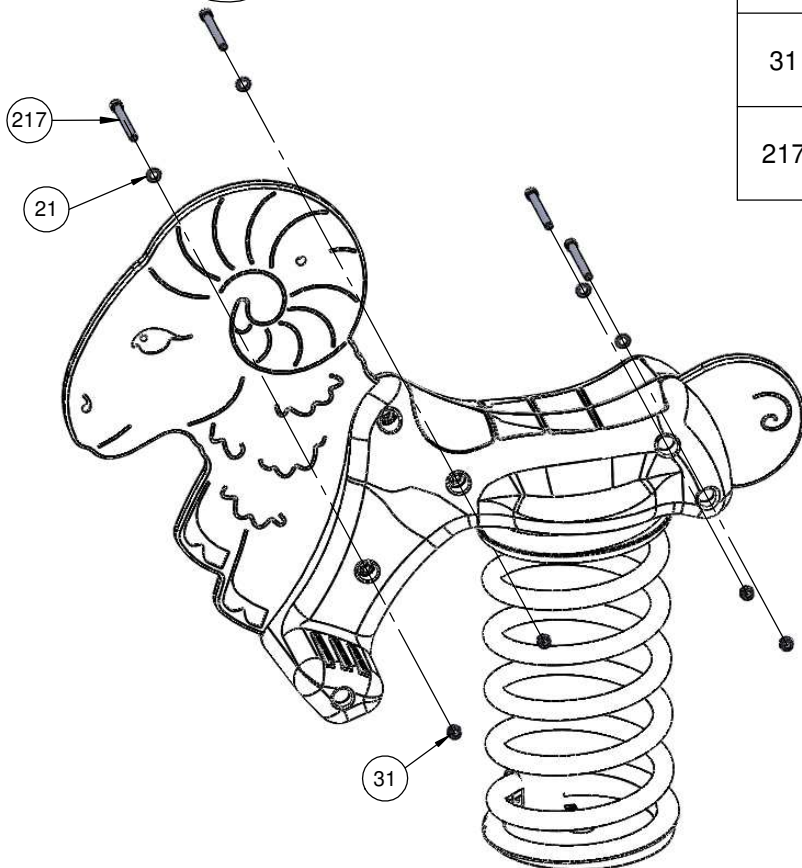

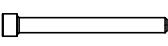

# 9 N, F

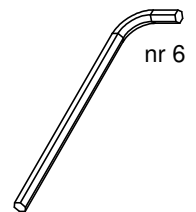

Nr	Element			Σ
21		DIN 125	8x16	4
31		DIN 985	M8	4
217		DIN 912	M8x80	4

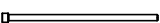

# 10 N, F

Nr	Element			Σ
21		DIN 125	8x16	2
31		DIN 985	M8	2
189		DIN 912	M8x200	1
216		DIN 912	M8x40	1

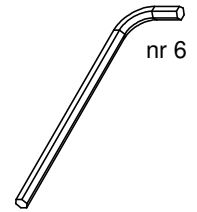
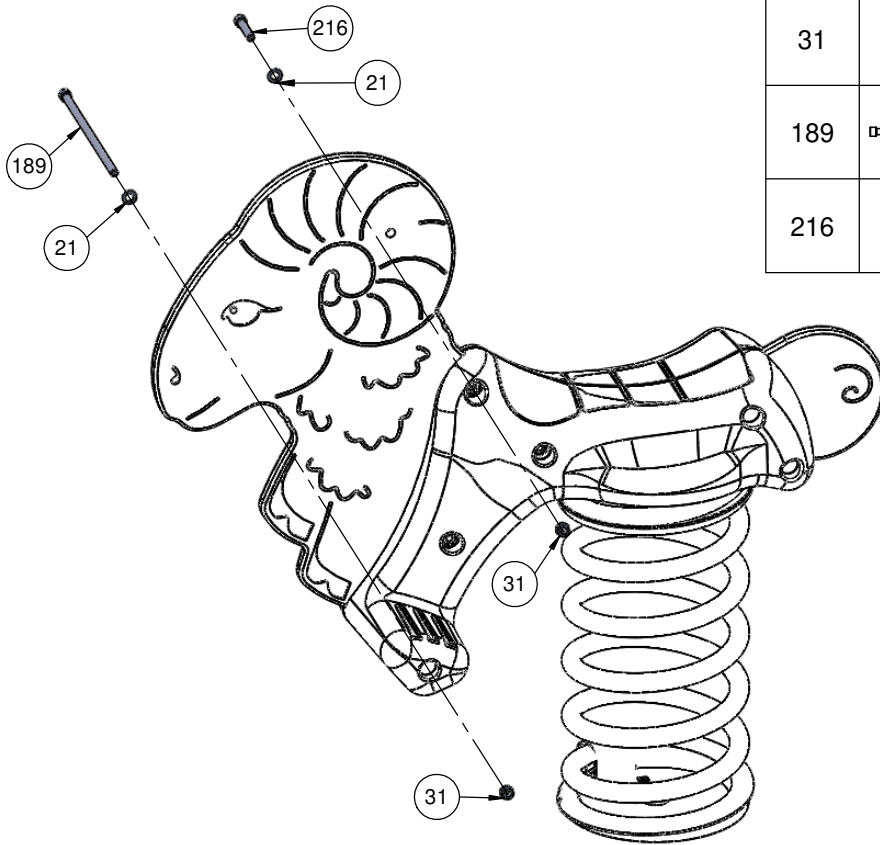





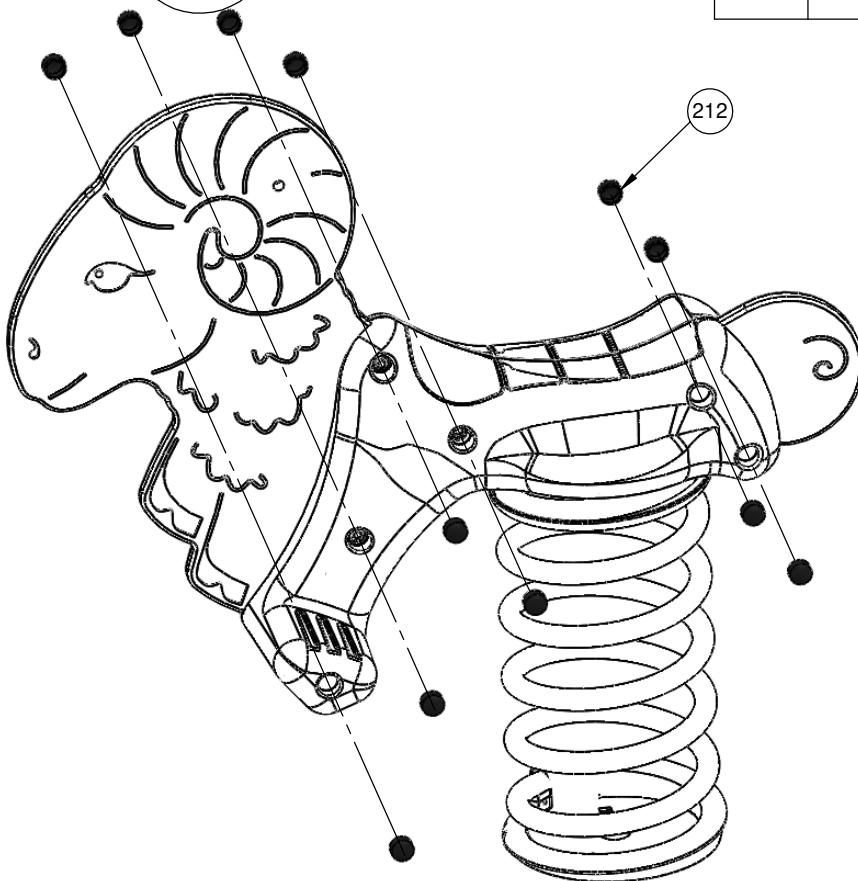

# 11 N, F

Nr	Element			Σ
203		-	Z_B_1_BR	12

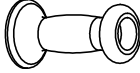

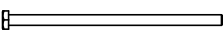

# 12 N, F

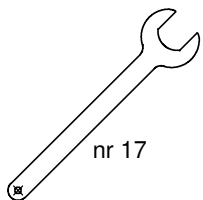
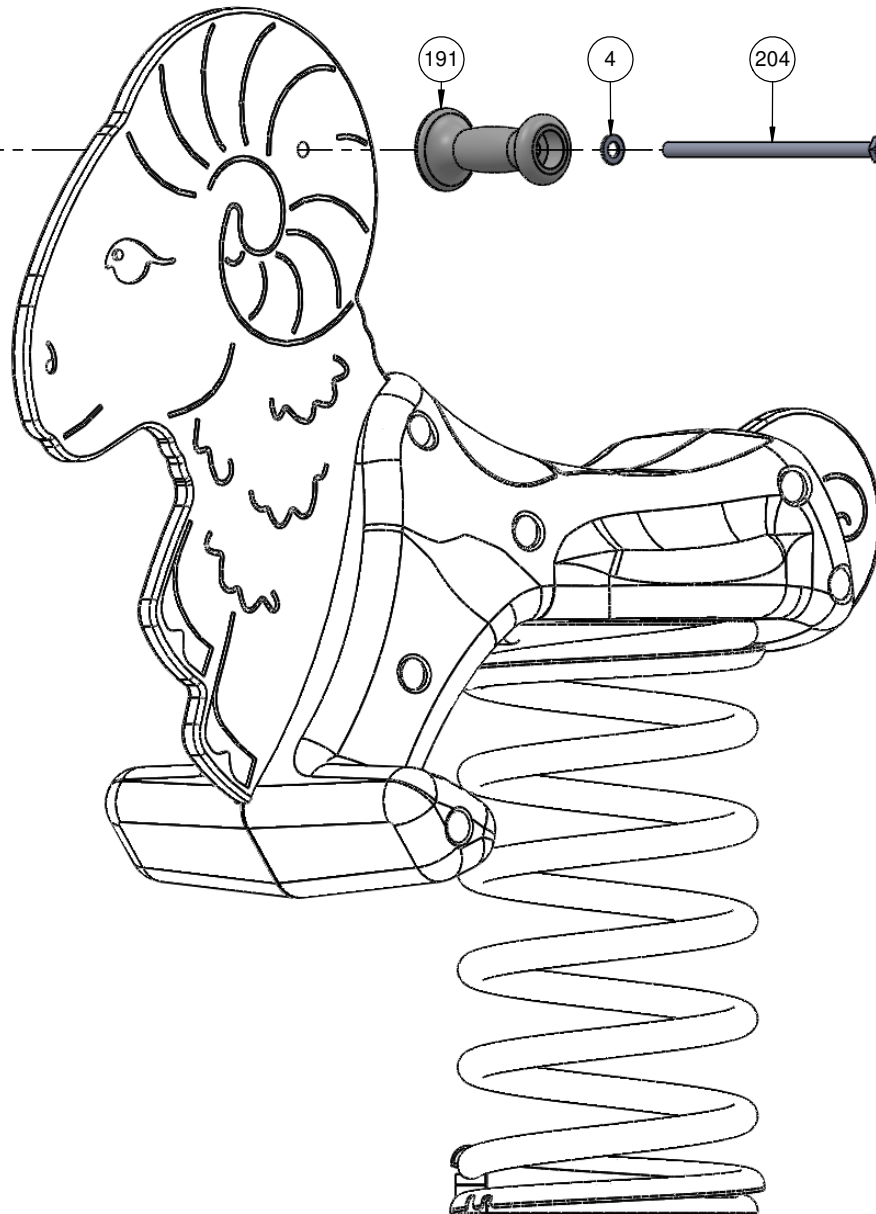
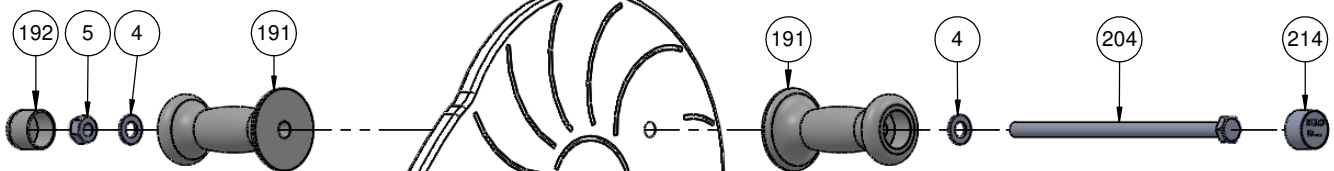
Nr	Element			Σ
4		DIN 125	10x20	2
5		DIN 985	M10	1
191		-	R_B_1	2
192		-	R_B_Z_1	1
204		DIN 931	M10x200	1
214		-	Z_NA_2	1





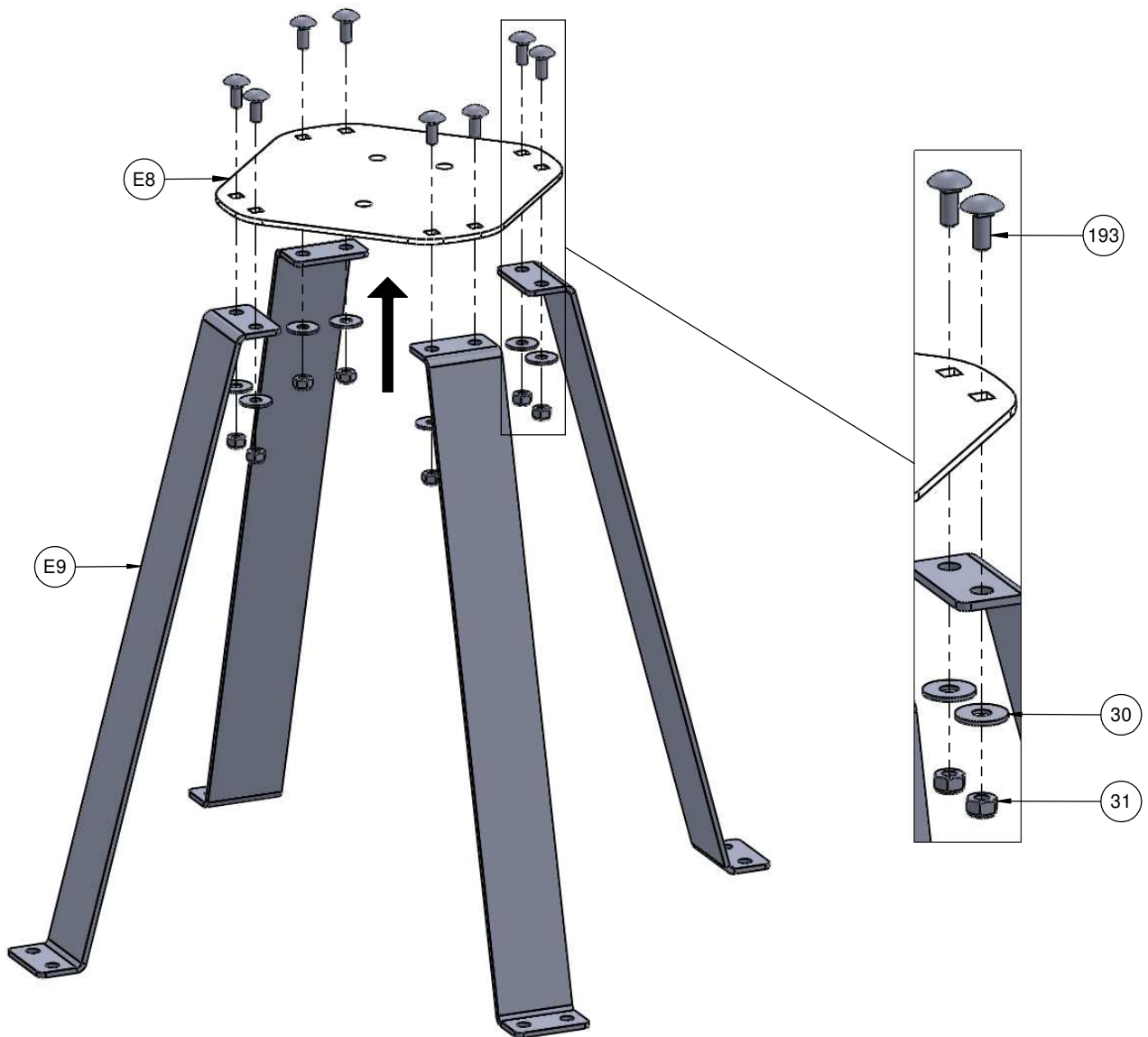
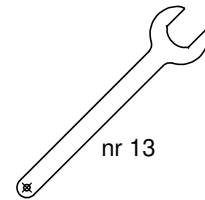

13 N

Nr	Element			Σ
30		DIN 9021	8x24	8
31		DIN 985	M8	8
193		DIN 603	M8x20	8



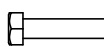

# 13 N

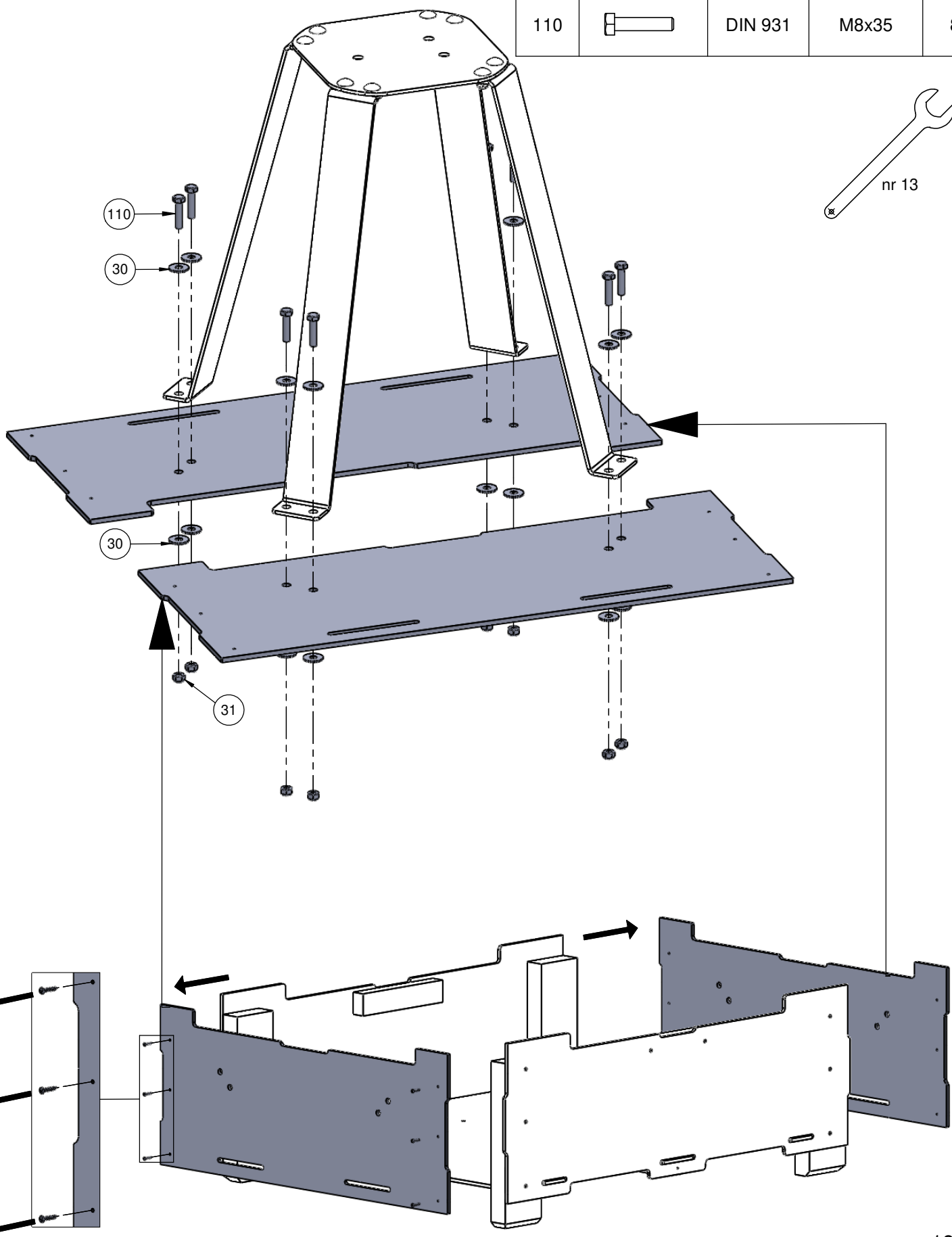
Nr	Element			Σ
30		DIN 9021	8x24	16
31		DIN 985	M8	8
110		DIN 931	M8x35	8



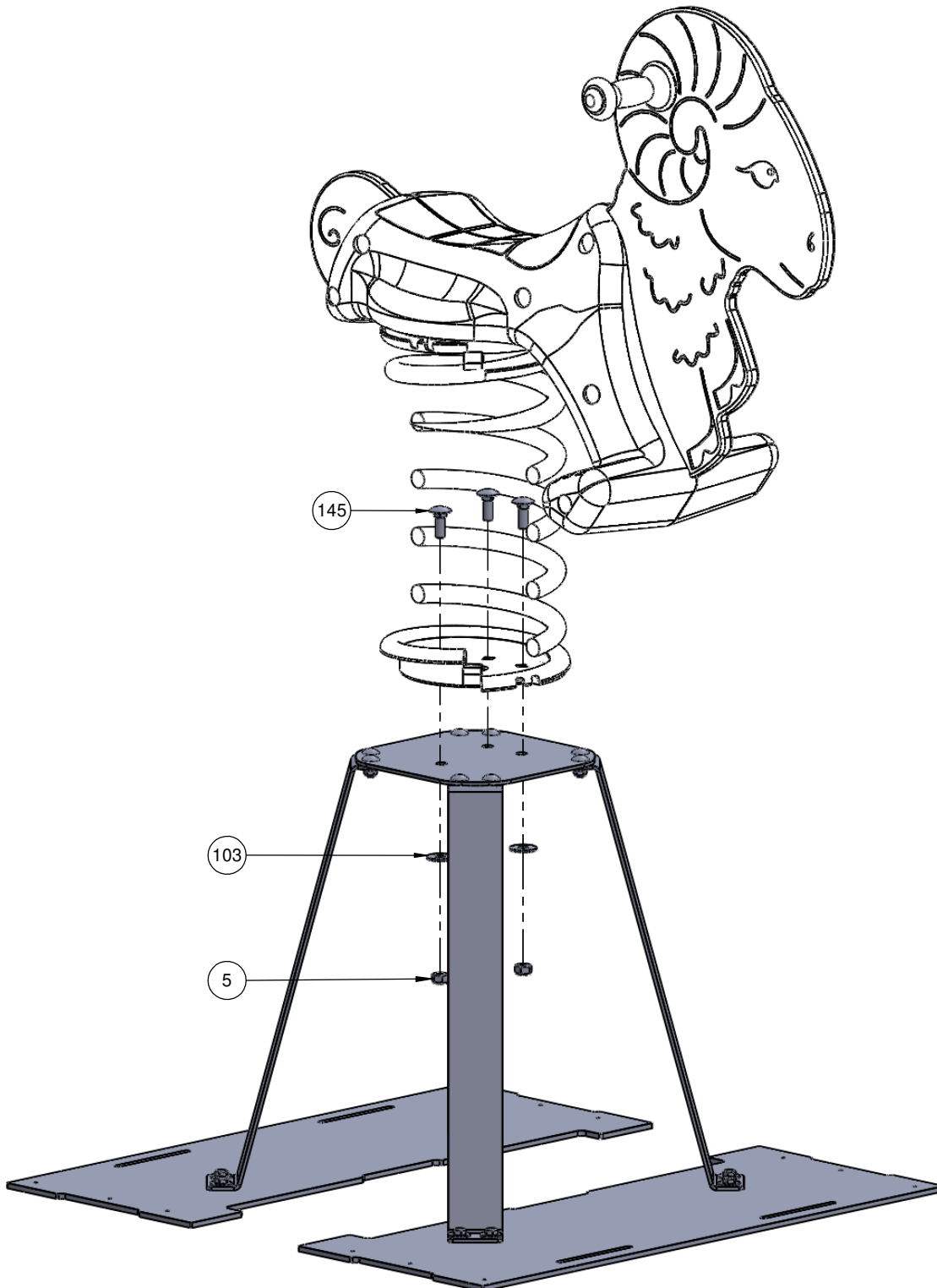
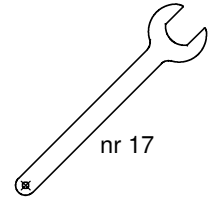

# 13 N

Nr	Element			Σ
5		DIN 985	M10	3
103		DIN 9021	10x30	3
145		DIN 603	M10x30	3



13

F

Nr	Element			Σ
5		DIN 985	M10	3
103		DIN 9021	10x30	3
145		DIN 603	M10x30	3

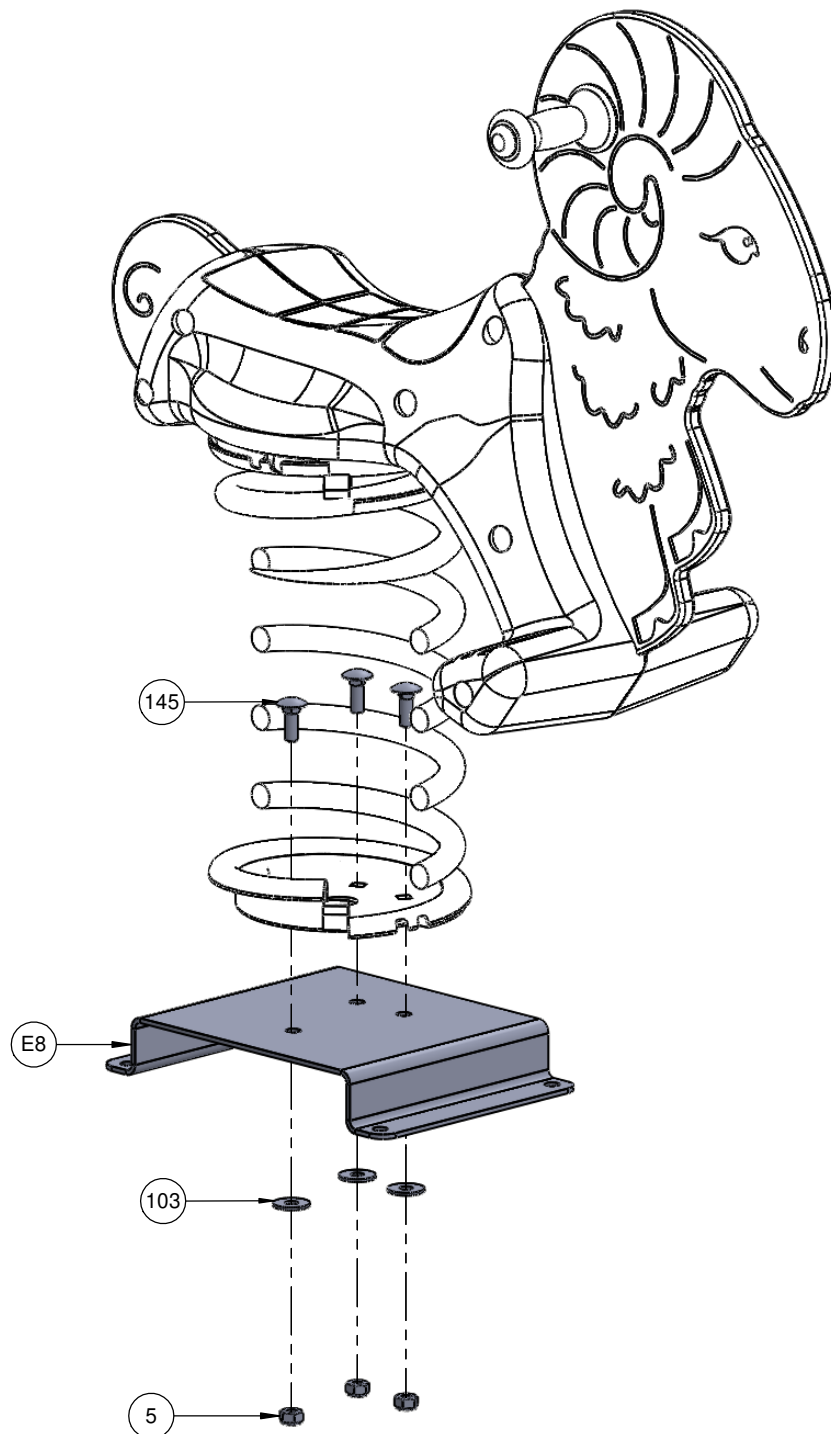
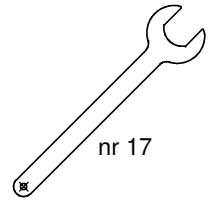

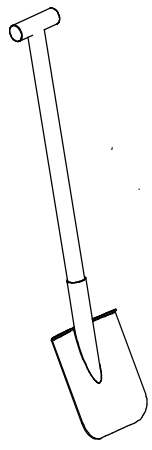

14N

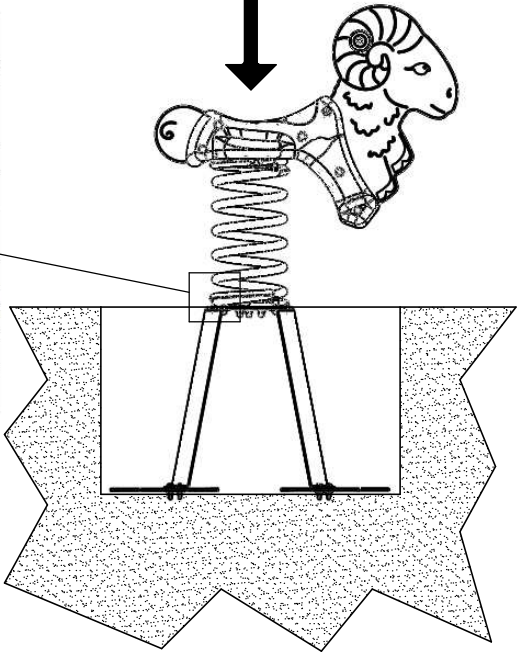
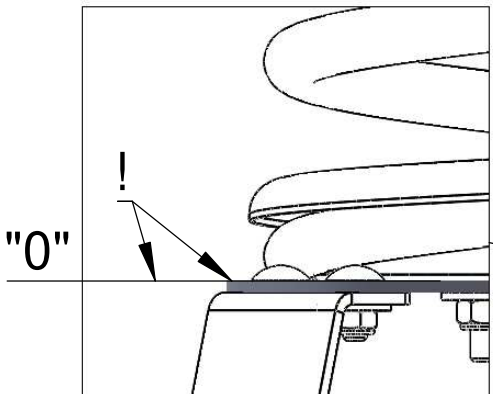
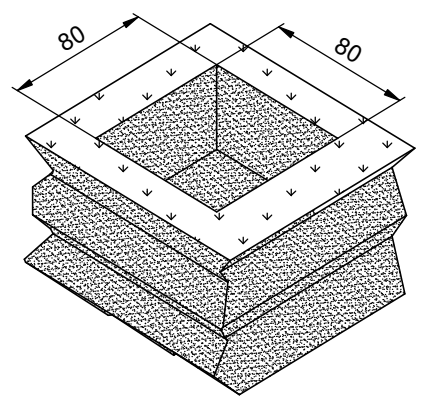
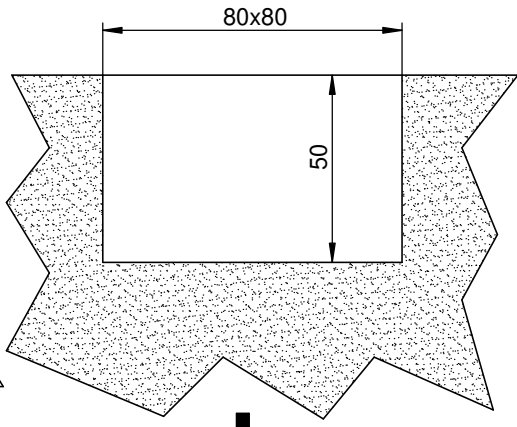
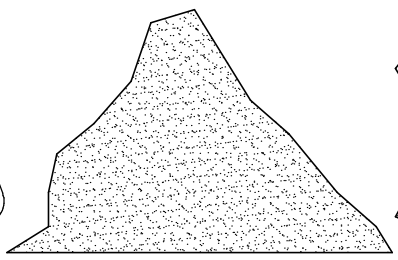

B15 0,1m<sup>3</sup> min. 48H

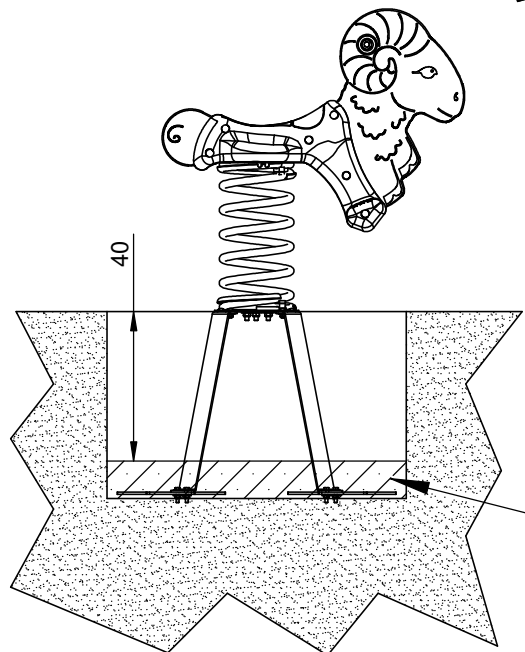
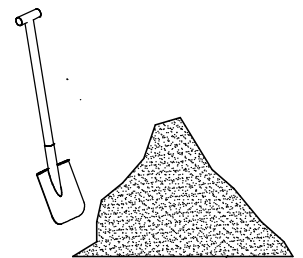
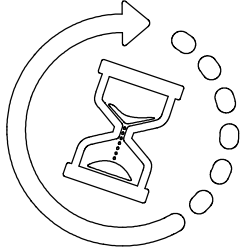
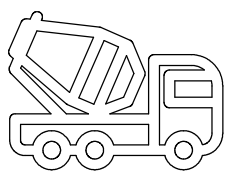

B15

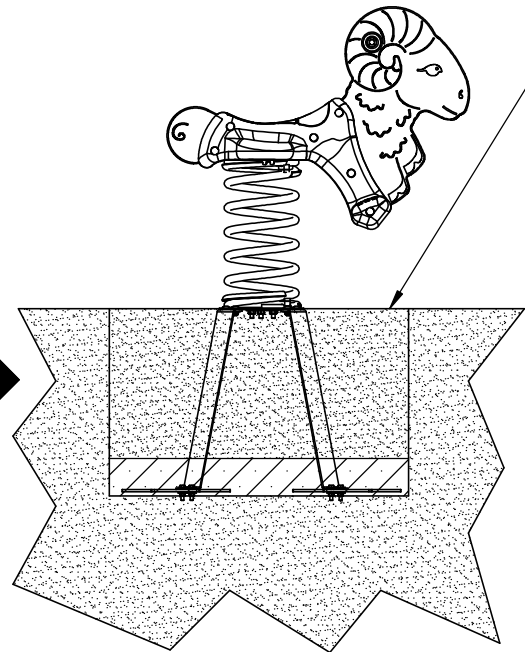

# 14 F

Nr	Element			Σ
61		-	KL105	4

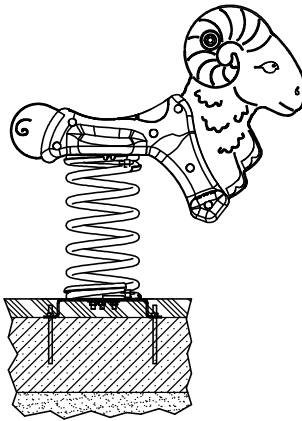

I

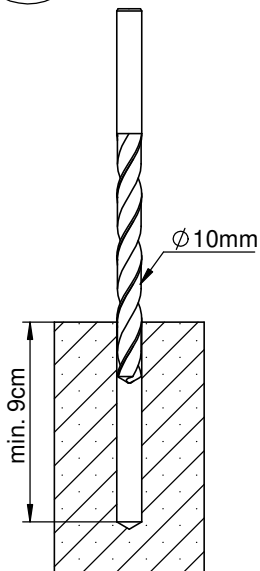

II

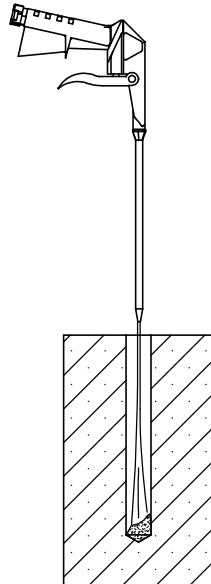

III

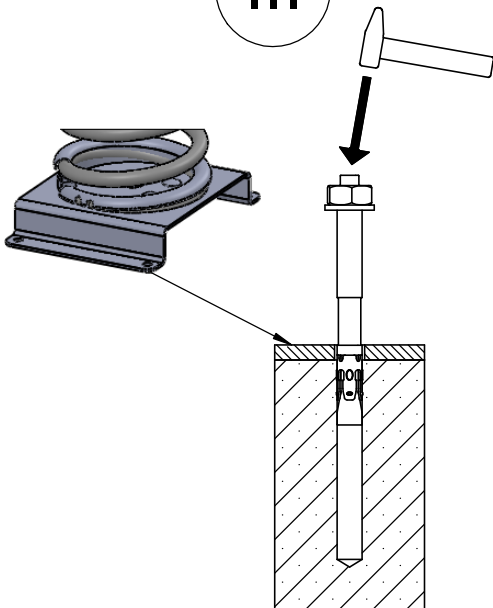

IV

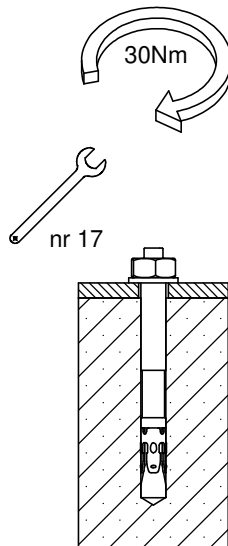

V

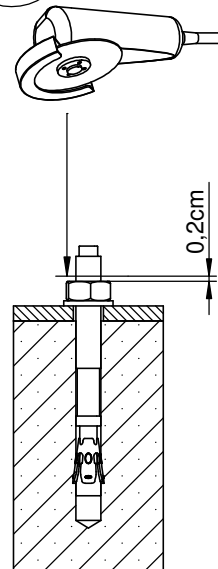

VI

