

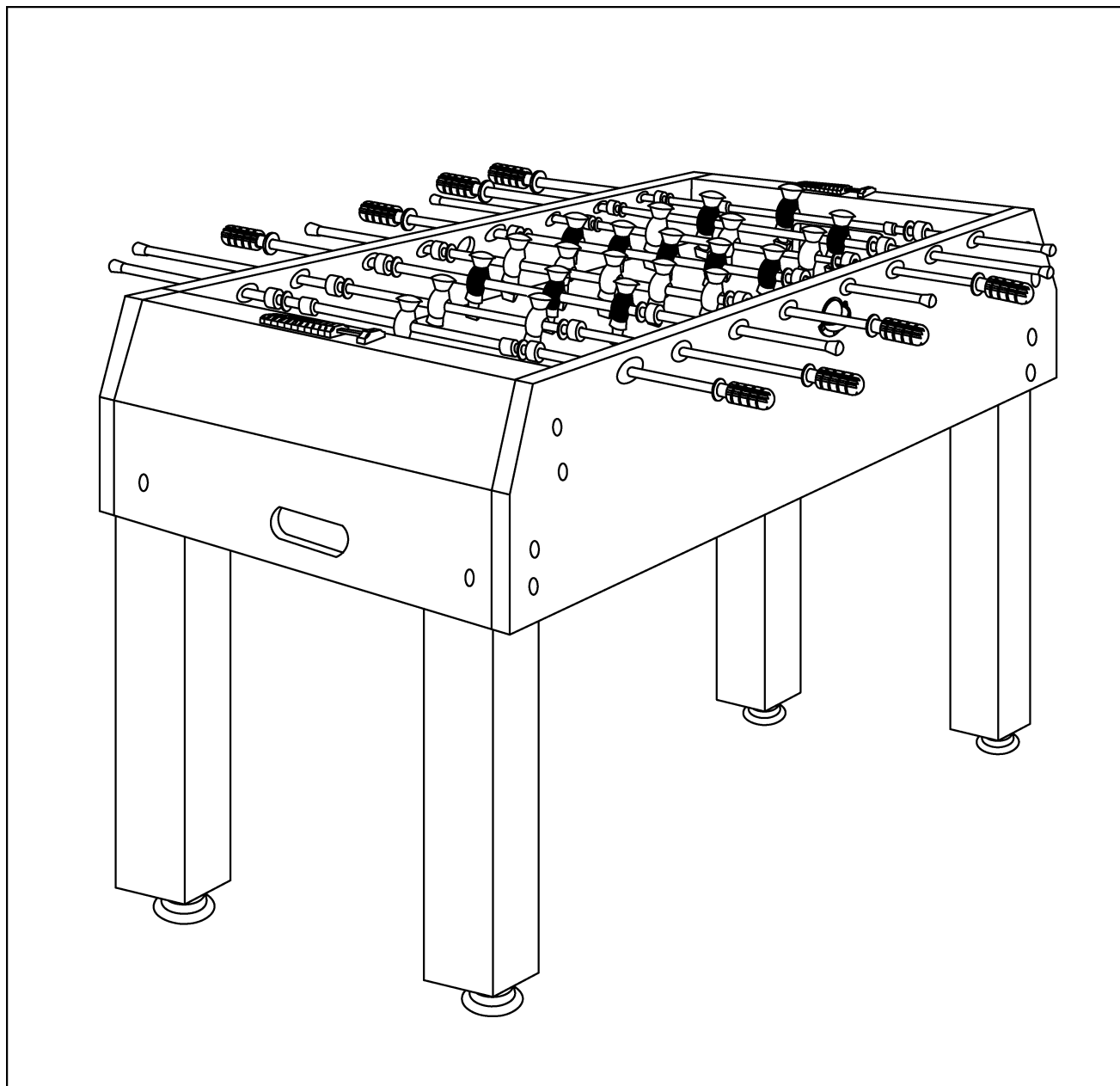

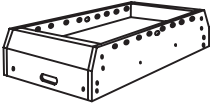

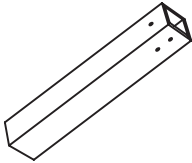





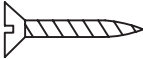
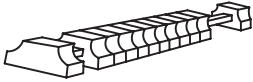

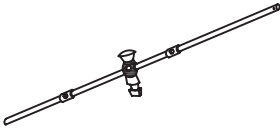
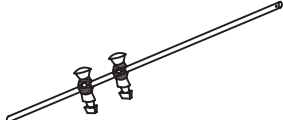
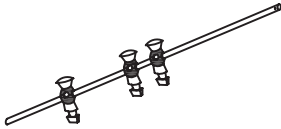
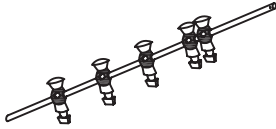
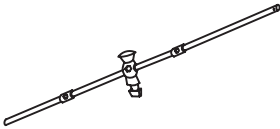
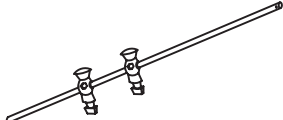
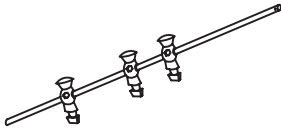
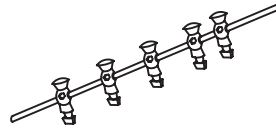
TISCHKICKER „FAMILY“



Bauteile

| | | | |
|---|--|---|--|
| <p>#1</p>  <p>Korpus 1 Stück</p> | <p>#2</p>  <p>Bein 4 Stück</p> | <p>#3</p>  <p>Schraube 12 Stück</p> | <p>#4</p>  <p>Unterlegscheibe 12 Stück</p> |
| <p>#5</p>  <p>Schraube 4 Stück</p> | <p>#6</p>  <p>Torzählwerk 2 Stück</p> | <p>#7</p>  <p>Höhenverstellbarer Fuß 4 Stück</p> | <p>#8</p>  <p>Stangenkappe 8 Stück</p> |
| <p>#9</p>  <p>Stange für einen Spieler Team A 1 Stück</p> | <p>#10</p>  <p>Stange für zwei Spieler Team A 1 Stück</p> | <p>#11</p>  <p>Stange für drei Spieler Team A 1 Stück</p> | <p>#12</p>  <p>Stange für fünf Spieler Team A 1 Stück</p> |
| <p>#13</p>  <p>Stange für einen Spieler Team B 1 Stück</p> | <p>#14</p>  <p>Stange für zwei Spieler Team B 1 Stück</p> | <p>#15</p>  <p>Stange für drei Spieler Team B 1 Stück</p> | <p>#16</p>  <p>Stange für fünf Spieler Team B 1 Stück</p> |
| <p>#17</p>  <p>Kickergriff 8 Stück</p> | <p>#18</p>  <p>Unterlegscheibe 16 Stück</p> | <p>#19</p>  <p>Puffer 16 Stück</p> | <p>#20</p>  <p>Schraube 8 Stück</p> |
| <p>#21</p>  <p>Mutter 8 Stück</p> | <p>#22</p>  <p>Balleinwurfschale 2 Stück</p> | <p>#23</p>  <p>Schraube 6 Stück</p> | <p>#24</p>  <p>Kickerball 2 Stück</p> |

#25



Inbusschlüssel
1 Stück

Schritt 1:

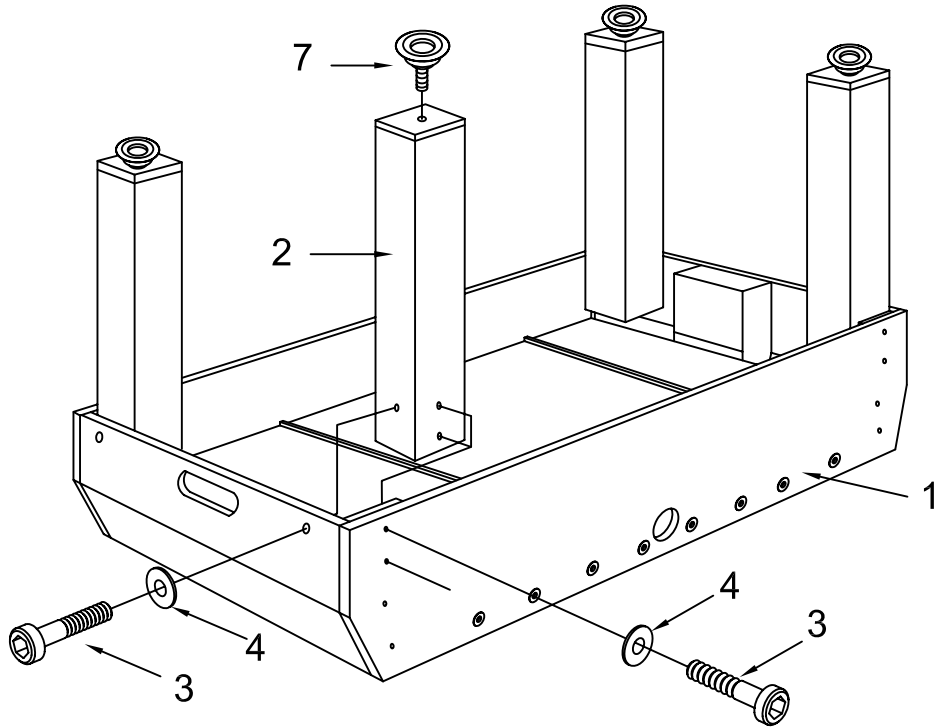

Schritt 2:

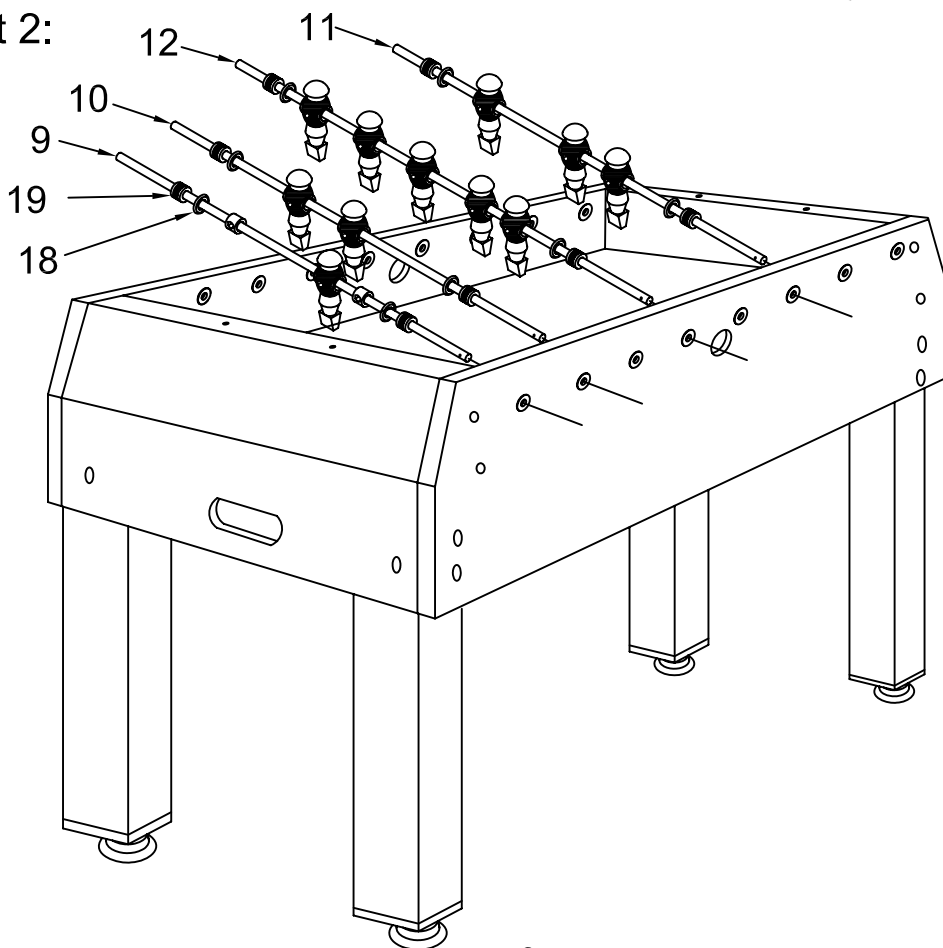

Schritt 3:

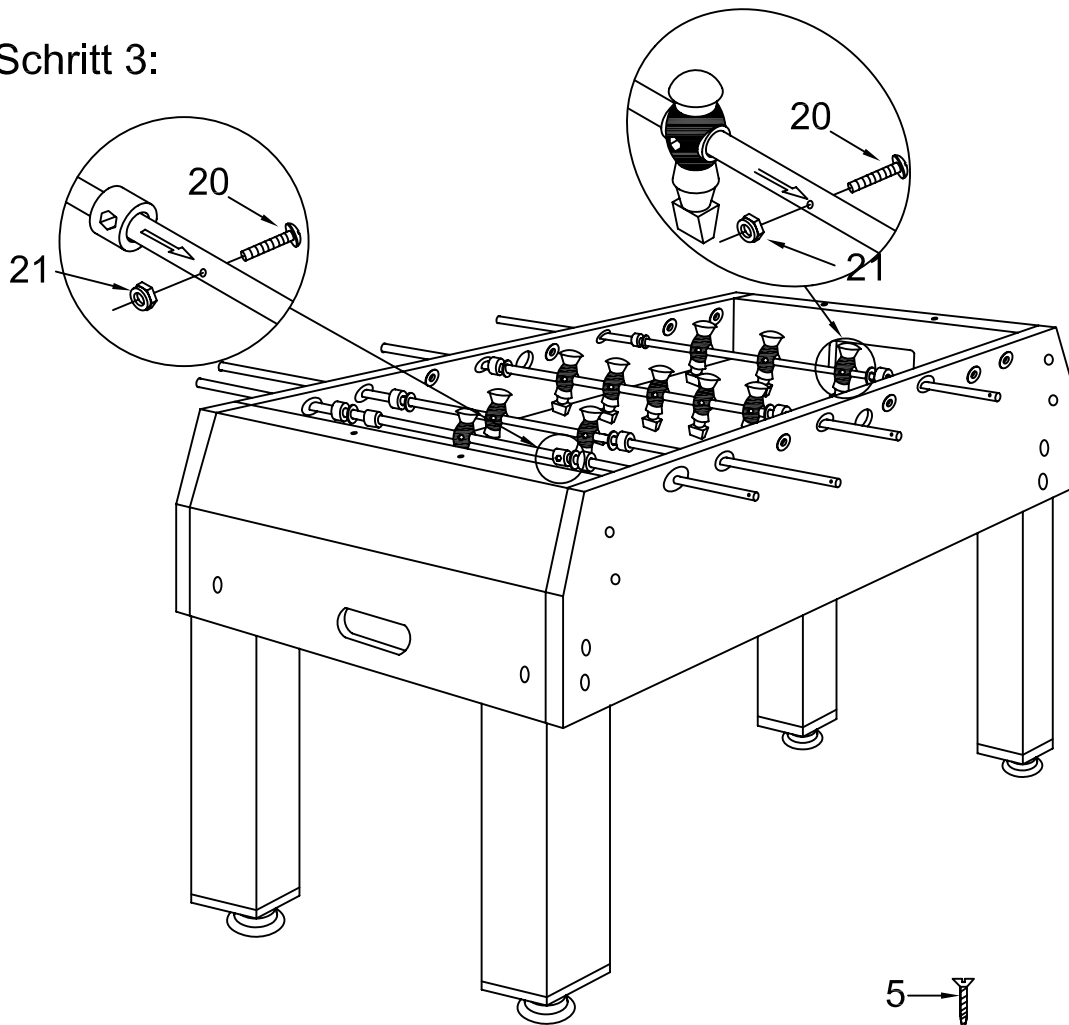

Schritt 4:

